



EVA System User Manual

Revision History			
Rev. no.	ECO/ CAPA/ SWC	Change Description	Date
01	CAPA 20005 ECO 334, ECO 335, SWC 336	Unify the following user manuals into one document: AUM-001 (Becomes obsolete), PUM-001 (Becomes obsolete), 10-LB-004 (becomes controlled reference document). Update to features according to ECO's/SWC's. Add VisualCheck	26/Nov/2020
02	NA	Update User Guide Name, rephrase section 1 intro (General)	10/Jan/2021
03		Following sections were updated: Update VisualCheck flow – section 15.5 Handwave settings screenshots - Section 11.21 “About” section (replaced “Settings”) – Sections 11.20, 11.4.6, 11.7.4 High contrast filter on portal - Section 10.9.10 Search bar on app – Sections 11.19 Quality frame screenshot - Section 11.25	24/Jan/2021
04	SWC 338	Add SANE Bluetooth foot pedal section 13.3.3 Limited capture images for demo account – section 11.9.11 Limitation of active logins 11.4, 10.6 reCaptcha- section 10.5 , 11.3	22/Feb/2021
04	SWC 339+3 40	6 digit PIN code policy – Updated sections and screenshots 11.1.8, 11.1.10, 11.5, 11.6.1 Re-enter password screenshot 10.4 Change sign in screens – 11.7.3, 11.1.5, 11.1..6 Updated screenshot – 10.8.1 Change “Sign in” to “Log in” + screenshots – 11.2, 11.7.1, 10.1, 10.3 Added message on sign in screens – updated screenshots 11.7.3 Stronger password policy – 11.7.4, 10.2.8, 10.4.4	22/Apr/2021
	Rolling Stand	Updated section 2.1.1.5	08/Aug/2021
	Hardware section	Figures numbering organizing – sections 2.1.3, 2.2, 3.1, 4.1, 4.2, 4.3, 7.2.2, 7.3.2, 7.4.2	13/Oct/2021
05	NA	Update intended use, addition of Medical Device symbol	2021 / 12 / 20

Approval Matrix				
	Name	Position	Signature	Date
Written by	Almog Avivi	Product Manager	--	
Updated by	Yana Katsman	QA/RA Manager		2021 / 12 / 20
Reviewed by	Liat Arbeitman	VP Operations		2021 / 12 / 20
Approved by	Leon Boston	CEO		2021 / 12 / 20

EVA (Enhanced Visual Assessment) System

User Manual

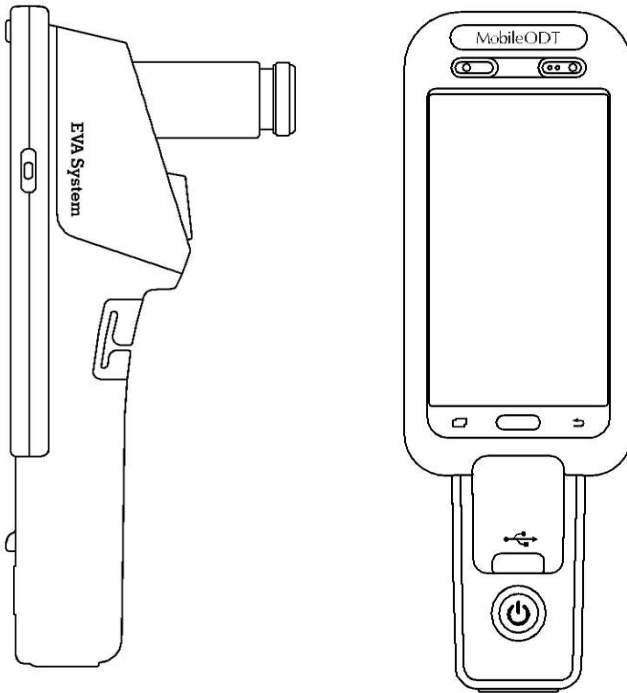

Table of Contents
Hardware7

1. General.....	8
1.1. Indications for Use	9
1.2. Contraindications	9
1.3. Risks and Benefits	9
1.4. How to Read These Operating Instructions	9
1.5. Symbols and Markings	9
1.6. Important Notes on Safety.....	10
1.7. List of Warnings	10
1.8. List of Precautions.....	11
1.9. Product Overview	11
1.10. Components.....	11
1.11. Primary Function.....	12
2. EVA System device.....	13
2.1. Connecting to the EVA stand or a neck strap.....	15
2.2. Turning on the LED light.....	18
3. Charging.....	19
3.1. Charging the Optical Unit.....	19
3.2. Charging the Mobile Device	20
4. Taking the Mobile Device out of the Optical Unit.....	21
4.1. To remove the mobile device from the optical unit (figure 17):.....	21
4.2. To insert the mobile device into the optical unit (figure 18):	21
4.3. OPTIONAL: To secure the phone into the EVA System device, preventing users from removing the phone from the optical device (figure 19):	21
5. Care and Maintenance.....	23
5.1. Storage	23
5.2. Lens Care.....	23
5.3. Body/Base	23
5.4. Cleaning Instructions.....	23
6. Troubleshooting & Support	24
6.1. Mobile Unit Troubleshooting.....	24
6.2. Lens Troubleshooting.....	24
6.3. Mobile Device Troubleshooting	25
6.4. EVA Application Troubleshooting	25
7. How to Capture a Clinically Useful Image	26
7.1. Stability	26
7.2. Positioning	26
7.3. Illumination	27

7.4. Focus	27
8. Specifications	29
8.1. Electromagnetic compatibility - manufacturer declaration	30
8.2. Electromagnetic emissions	30
8.3. Recommended separation distances	32
9. Replacement parts and technical service	34
Software.....	34
10. EVA Portal	35
10.1. Welcome screen.....	35
10.2. Setting up a user	35
10.3. Signing in	36
10.4. Forgot password	37
10.5. Viewing patient records	38
10.6. Searching for patient records.....	39
10.7. Reviewing and editing patient examination records	39
10.8. Editing the Exam	39
10.9. Viewing images and annotations	40
10.10. Adding notes	42
10.11. Help	42
10.12. Export & Download	43
11. EVA System software application	46
11.1. Setting Up a New User	46
11.2. Log in (existing user)	49
11.3. Reset PIN	49
11.4. Changing the user	50
11.5. Reset EVA account password	51
11.6. Opt-out status	52
11.7. Notification Center.....	53
11.8. Performing an exam.....	54
11.9. Capture images	56
11.10. Changing settings during an exam (Camera menu)	58
11.11. Review media files	59
11.12. Add annotations.....	59
11.13. Summary	61
11.14. Exporting the exam	61
11.15. Back up exams on a local drive:	63

11.16.	Limited storage preventing export.....	64
11.17.	Reviewing exams on the app	64
11.18.	Deleting an exam	67
11.19.	Exam Drafts	68
11.20.	About	68
11.21.	Handwave feature.....	69
11.22.	Camera mode.....	69
11.23.	Quality frame	69
11.24.	Support	70
11.25.	Learn	70
11.26.	Log out	70
Appendices		71
12.	Appendix 1: EVA COLPO	72
12.1.	Add history of present illness.....	72
12.2.	Colposcopic impression.....	72
12.3.	Optional features	73
13.	Appendix 2: EVA SANE	74
13.1.	Add additional details	74
13.2.	Add clinical impression	74
13.3.	Additional features	75
14.	Appendix 3: EVA VIA	77
14.1.	Add additional details	77
14.2.	Add clinical impression	78
14.3.	Optional features	78
15.	Appendix 4: VisualCheck.....	79
15.1.	Intended use	79
15.2.	Target population.....	79
15.3.	Warnings and Precautions	79
15.4.	Performing VisualCheck assessment.....	80
15.5.	Running the VisualCheck analysis from the EVA device.....	80
15.6.	Running VisualCheck analysis from the EVA Portal.....	81
15.7.	VisualCheck results	82
16.	Appendix 5: Quality frame	84
16.1.	Using the Quality frame	84
17.	Appendix 6: Teleconsultation (Zoom Telehealth)	85
17.1.	Installing the Zoom Application	85

17.2.	Initiating a teleconsultation connection	85
-------	--	----

Hardware

1. General

Thank you for purchasing the EVA System by MobileODT. Please read the instructions contained in this user guide thoroughly before using your new visualization solution. This user guide can be found online at help.mobileodt.com.

This user guide will help all users including those utilizing one of our clinical scenarios (please see appendices COPLO, SANE and VIA) for our device model: **EVA 3 Plus**

*For those users on EVA 3 please contact support for additional information on hardware maintenance and support)

For further support, please contact us:



MobileODT, LTD.
Ben Avigdor 8,
Tel Aviv, Israel 6721832
Email: support@mobileodt.com
Tel.: +1 (617) 454-4687
Website: www.mobileodt.com

The following is the contact information for the European Authorized Representative used for this device:

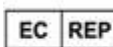
 MedNet EC-REP GmbH
Borkstrasse 10, 48163 Muenster, Germany
<http://www.mednet-eurep.com>



FULL TRAINING FOR USE OF THE EVA SYSTEM
CAN BE FOUND AT:

[HTTP://LEARN.MOBILEODT.COM](http://LEARN.MOBILEODT.COM)

[HTTP://HELP.MOBILEODT.COM](http://HELP.MOBILEODT.COM)

1.1. Indications for Use

The EVA (Enhanced Visual Assessment) System is intended to provide magnified viewing of the vagina, cervix and external genitalia in order to aid in diagnosing abnormalities and selecting areas for biopsy.

The device is intended for use in hospitals, doctor’s offices, and remote and rural clinics.

1.2. Contraindications

There are no contraindications for use of the EVA System.

1.3. Risks and Benefits

The EVA System should not touch the patient. There are minimal risks to the patient. The system has been tested according to specific medical standards.

1.4. How to Read These Operating Instructions

These instructions are structured around the operation of the EVA System, from assembly to clinical use. Basic troubleshooting information is also provided.

The following content contains instructions for the assembly and use of the EVA System colposcope.

Instructions for the integrated mobile application and cloud-connected online portal are referenced in the manual.

1.5. Symbols and Markings











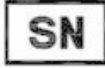

General warning sign



Stand by symbol

Press this button to turn on the LED light. Press the button a second time to turn it off.

<i>Symbol</i>	<i>Description</i>
	Serial Number
	Catalog Number
	Refer to instruction manual/booklet
	Prescription use only
	CE Mark
	Waste of Electrical and Electronic Equipment (WEEE) compliance symbol
	Manufacturer
	Date of Manufacture
	Authorized Representative in the European Union
	DC (Battery)

	Keep away from sunlight
IPXY	IP (International Protection) code
MD	Medical Device

In the United States, federal law restricts prescription medical devices to be sold by or on the order of a physician or properly licensed practitioner.

1.6. Important Notes on Safety

Before you begin using the EVA System, please become familiar with the following safety regulations and keep these in mind while using the device.

Users of the EVA System should be thoroughly trained in the appropriate medical procedures. All users need to read and understand these instructions before performing any procedure.

1.7. List of Warnings



The warning statements in this manual describe serious adverse reactions and potential safety hazards, limitations in use imposed by them, and steps that should be taken if they do occur.

- 1.7.1. Local and/or other applicable laws may restrict the sale of this device to, or to the order of, a physician or other appropriately licensed medical professional. The EVA System may not be used unless you or your organization meet the requirements and/or obligations under such laws and you assume full responsibility for any illegal purchase and/or use of the device. The EVA System should only be used by a trained and licensed operator, whose accreditation is valid in the country and/or region in which the procedures are being conducted.
- 1.7.2. All service to the EVA System must be performed by MobileODT or an authorized repair center. There are no user serviceable parts in this unit or in its accessories (other than the mobile device). Any attempt to disassemble and/or repair this unit will result in voiding of the warranty.
- 1.7.3. Capture images only within the EVA application.
- 1.7.4. The attached lens should not be removed from the unit it was sent with, without written approval from the manufacturer.
- 1.7.5. The LED light is extremely bright and should be the only illumination used as a light source during an examination. Do not stare directly into the light when it is in operation.
- 1.7.6. The system, both optical unit and mobile device, should not be used while being charged. Users are requested to take care to charge the system before use.
- 1.7.7. Only the dedicated mobile device that comes with this optical unit and complies with relevant safety standards can be used with the EVA System.
- 1.7.8. When transmitting data from the EVA application over a WiFi network, only use a password-protected connection (WPA2, not WPA or WEP).
- 1.7.9. In environments where mobile devices are restricted, the EVA System can be used in airplane mode. Wherever mobile devices are permitted for use, the EVA System can be used in its online-connected mode.
- 1.7.10. This device contains lithium batteries. A battery replacement by inadequately trained personnel could result in a hazard (such as excessive temperatures, fire or explosion), and therefore should be sent back to MobileODT for service.

- 1.7.11. The EVA System should be charged using a standard micro-USB charger for mobile device charging. A single or dual port USB charger may be used, but it is recommended to use the charger provided with the system for optimal results. Specifically, a 5V DC with a current capacity of 2A, regardless of the power supply input.

1.8. List of Precautions

Precautions in this manual regard the special care exercised by the practitioner for the safe and effective use of the colposcope.

- 1.8.1. Do not allow the colposcope to come in contact with the patient.
- 1.8.2. Do not touch the optical lens or LED light except as described in the maintenance section of this manual.
- 1.8.3. Do not immerse any part of the colposcope in cleaning solutions or any fluid.
- 1.8.4. Do not use strong detergents or alcohol under any circumstances for optics cleaning. This would lead to irrevocable damage to the optically-coated lens surfaces.
- 1.8.5. To limit contamination, use recommended disinfectant agents between each exam.
- 1.8.6. Do not use corrosive materials or strong cleaning materials other than those specifically prescribed on the casings or on the optics. Such materials lead to permanent damage of the painted surface of your colposcope and/or scratch the lens coatings of the optics. This leads to considerable loss of quality of the entire visual system.
- 1.8.7. The EVA System was built to be resilient, but needs to be taken care of like any other electronic device. It should never be stored or operated in areas where it could get wet or could be exposed to environmental conditions such as extreme temperature or humidity, prolonged direct sunlight, dust, etc.
- 1.8.8. If the LED light ceases to work, due to battery drain or LED burn out, stop using the colposcope and recharge the batteries. Sometimes a discharged battery will manifest via a flickering LED. In this case, recharge the battery to full capacity before continuing use.
- 1.8.9. No modification of this equipment is recommended.

1.9. Product Overview

Before use of your colposcope, check for damage on the outside of the transport packaging, the optical unit, mobile device, and any accessories.

The following chapters provide step-by-step instructions for the testing, installation, operation, and security references.

1.10. Components

Before initial setup of the EVA System, check that you have received all the following components:

- Optical unit body and lens
- Samsung J530 mobile device*
- Syncwire 2 Ports 30W/6A Dual Port MicroUSB Charger
- Spare parts kit including: 1 charging cable, 2 technician screws and an Allen key
- Neck strap
- Lens cleaning cloth
- User guide

If any parts are missing, please notify MobileODT.

* Please refer to the Samsung J530 user manual to find specifications regarding the WiFi, how the mobile device should be configured and operated including the quality of service, operating distances and ranges,

security requirements, and how to deal with any risks and problems that may arise.

1.11. Primary Function

To avoid doubt, the primary function of the EVA System is for mobile colposcopy, the magnified viewing of the tissues of the vagina, cervix, and external genitalia for the purpose of conducting colposcopy. Use of the colposcope and its primary function of visualization is not dependent upon constant WiFi or mobile connection. If interference from other WiFi devices affects the WiFi connection or if the WiFi connection is interrupted or lost due to any other reason, the colposcope can still function as intended and images will be synced and accessible on the online portal when a connection is restored.

2. EVA System device

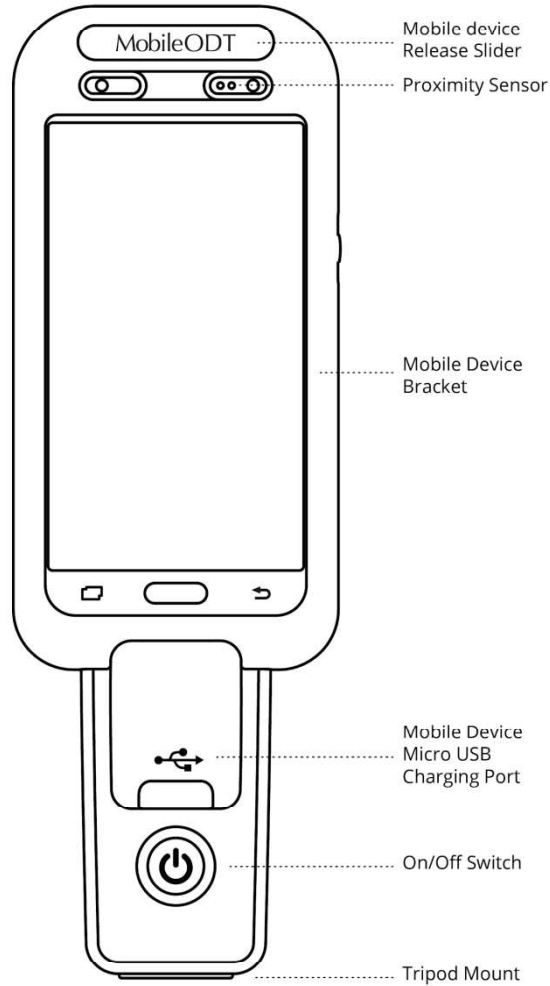

Back View (figure 1)

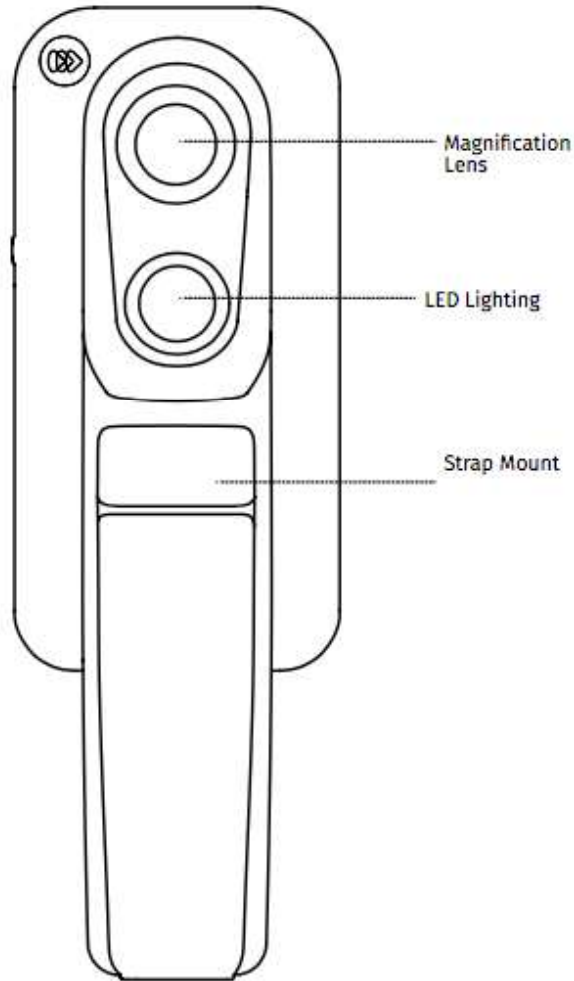

Front View (figure 2)

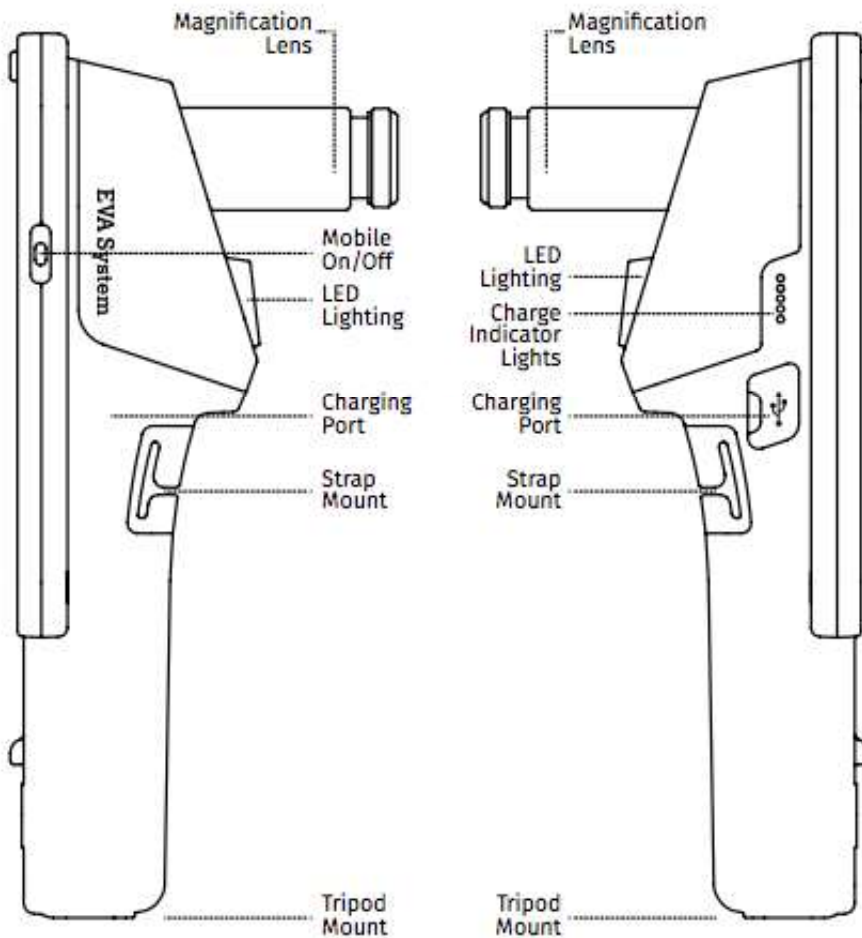

Left View (figure 3)

Right view (figure 4)

2.1. Connecting to the EVA stand or a neck strap

Together with your EVA System, MobileODT provides a device stand for stabilizing the colposcope while capturing an image. There are two types of stands: a wheeled stand and a portable stand. Below are basic instructions on connecting the colposcope to both models. See the detailed assembly instructions that came with the stand itself for further explanations.

2.1.1. Wheeled Stand

- 2.1.1.1. The wheeled stand enables hands-free examination and allows you to move freely within your clinic while keeping the EVA System connected to the stand at all times.
- 2.1.1.2. The wheeled stand arrives in two distinct parts: the base and the pole. During the exam, the stand wheels should be locked manually to improve stability and limit motion blur.
- 2.1.1.3. In addition, the 360° ball head can be adjusted during the example to improve the ability to visualize the cervix at the necessary angle.
- 2.1.1.4. To assemble the stand, use the provided key to screw the pipe with the ball-head to the base with help of M6 self-locking nut, M6 washer and spring washer included in the shipment. Refer to the graphical instructions below.

2.1.1.5. There are two stand models that are assembled according to the assembly instructions that are provided with the stand. The stand model is provided according to stock available.

2.1.1.5.1. A 3-legs stand:



2.1.1.5.2. A 4-legs stand:



2.1.2. Portable Stand

The portable stand also enables a hands-free examination. This stand can be carried from location to location, can be folded for portability between exam rooms, or put into the accompanied carrying case to move between clinical sites.

2.1.3. Connecting the Neck Strap

The colposcope can be connected to a neck strap for carrying the unit more comfortably around your clinic. Please follow the steps below to connect the neck strap to the colposcope securely:

- 2.1.3.1. To attach the strap to the device, first flatten the strap and slide it under one corner of the strap attachment slot.



(figure 5)



(figure 6)

2.1.3.2. Slide the strap under the second corner and pull through.



(figure 7)



(figure 8)

2.2. Turning on the LED light

Turn on the LED light by pressing the on/off button.



(figure 9)



(figure 10)

3. Charging

The EVA System includes two components: the optical unit and mobile device. Each needs to be charged separately.

2 Ports 30W/6A

A charger appropriate for over 150 countries is provided, in order to allow for charging in different countries.

Power: 30W

Input: 100-240V

Output: 3A*2

Technology: iSmart

Weight: 100g

Dimensions: 50mm*43mm*42mm

Certification: CE/FCC/UL/LVD

3.1. Charging the Optical Unit

- 3.1.1. To charge the optical unit, connect the Micro-USB charger to the unit's right side charging port. Connect the cable to a wall socket with the proper USB-electrical port adapter.







(figure 11)

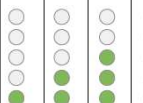

- 3.1.2. The charger included has two slots for USBs to allow charging in a single electrical outlet.
- 3.1.3. The Charge Indicator Lights can be found above the charging port on the front of the optical unit. When connected to the charger, the lights will turn on and turn green while charging.

Please Note: The colposcope cannot be used while charging, as the LED light will not be able to be switched on.

- 3.1.4. Charge indicator lights – operation mode

Setting	Indicators Status	Description
Device is OFF; Charger unplugged		All indicator lights are OFF
Device is ON; Charger unplugged; Battery is full		All 5 indicator lights are ON (solid green)
Device is ON; Charger unplugged; Battery partly-full		Bottom 1-4 indicator lights are ON (solid green), depending on battery status Top indicator light is OFF
Device is ON; Charger unplugged; Battery depleted		Bottom indicator light is ON (solid Orange), Top 4 indicator lights are OFF WLED off NOTE- auto turn off adjusted to 15 seconds for orange indicator LED

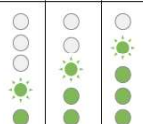
3.1.5. Charge indicator lights - charging mode

Setting	Indicators Status	Description
Device is OFF; Charger Plugged in; Battery is full		All 5 indicator lights are ON (solid green)
Device is OFF; Charging (charger plugged in); Battery partly-full		Bottom 1-4 indicator lights are ON (solid green), Next indicator light is blinking (green)
Device is OFF; Charging (charger plugged in); Battery depleted		Bottom indicator light is blinking (green)

3.2. Charging the Mobile Device

- 3.2.1. To charge the mobile device when it is fitted within the optical unit, connect the Micro- USB cable to the charging port built-in to the unit.
- 3.2.2. To access the port, raise the charging port cover located above the LED light on/off switch.
- 3.2.3. Connect the cable to a wall socket with the proper USB-electrical port adapter.
- 3.2.4. The mobile device should be charged whenever the colposcope is not in use to ensure proper functionality during the examination.



(figure 12)

4. Taking the Mobile Device out of the Optical Unit

For users of the SANE the mobile device should be taken out of the optical unit when capturing full body images in Camera mode.

For more information about Camera mode see appendix

4.1. To remove the mobile device from the optical unit (figure 14):

- 4.1.1. Slide the Phone Release Slider at the top of the device to the right.
- 4.1.2. Push the top bracket up.
- 4.1.3. Detach the top bracket from the optical device and remove the mobile device.
- 4.1.4. If a technical screw was manually added to secure the device, remove the technical screw with the provided allen key before removing the top bracket.

Please note: When the mobile device is removed from the optical unit the image will look inverted. To change it to a regular camera view, you must click on the settings icon at the top of the image capture screen and switch the 'capture mode' setting to 'camera mode. This will allow normal, uninverted imaging through the EVA application.

4.2. To insert the mobile device into the optical unit (figure 13):

- 4.2.1. Place the mobile device back into the optical unit.
- 4.2.2. Push the connectors of the top bracket into the slots of the optical unit, and then pull down to fully engage the top bracket with the optical unit.

4.3. OPTIONAL: To secure the phone into the EVA System device, preventing users from removing the phone from the optical device (figure 14):

- 4.3.1. Take 1 technical screw and the allen key from the spare parts kits included in your shipment.
- 4.3.2. Slide the Phone Release Slider at the top of the device to the right.
- 4.3.3. Place the technical screw in the allocated slot.
- 4.3.4. Use the allen key to tighten to screw.
- 4.3.5. Providers without the allen key may no longer remove the phone from the optical device.

To remove the mobile device from the optical unit:

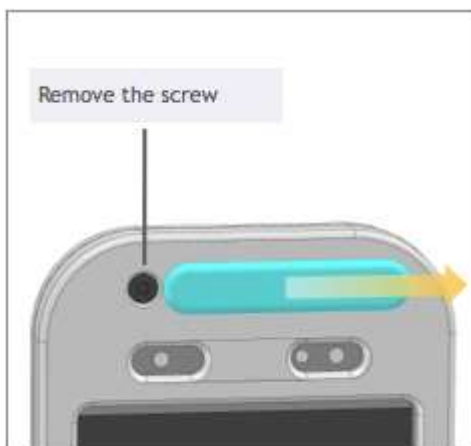

(figure 13)

To insert the mobile device into the optical unit:

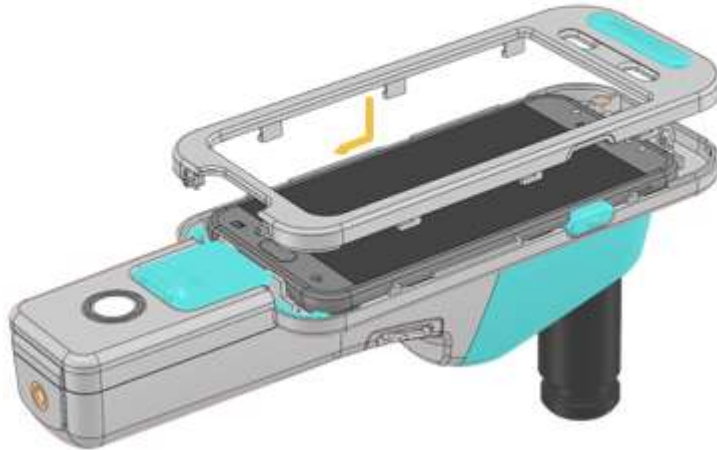

(figure 14)

To secure the phone into the EVA System device, preventing users from removing the phone from the optical device

Place the technician screw here.
Tighten with allen key.

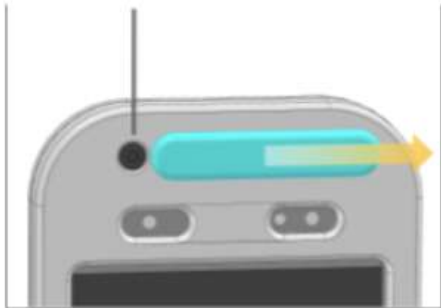

(figure 15)

5. Care and Maintenance

5.1. Storage

- 5.1.1. We recommend leaving the colposcope in its provided case for protection and to minimize dust contamination when not in use. Always follow the cleaning process outlined below prior to returning the unit to its case to avoid contamination.

5.2. Lens Care

- 5.2.1. The optical unit lens should be kept free from loose debris or dust particles that may block the field of view. In the event of dirt or smudges on the lens surface, clean the lens with a soft cloth or lens wipe. We recommend using the cloth provided in your care kit. Never use towels.

5.3. Body/Base

- 5.3.1. The optical unit needs to be cleaned between each and every use due to the colposcope accumulating dirt over time, and the possibility of cross-contamination.

5.4. Cleaning Instructions

Cleaning the base of the optical unit should only be done with disinfectant towelettes, such as CaviWipes or their equivalent.

- 5.4.1. Use 3-5 towelettes, at minimum, to wipe the optical unit body from the handle, both down the internal side facing the user and the external side facing the patient, making your way to the top of the unit.
- 5.4.2. This should be done in a scrubbing motion, covering both sides of the plastic body.
- 5.4.3. Be sure to cover all areas and crevices so that the entire surface body of the unit is wiped down.
- 5.4.4. Don't clean the unit when the rubber cover over the charging port is open to avoid damage to the charging port.
- 5.4.5. Continue by wiping the lens around the perimeter of the aluminum tube with a dedicated optics cleaning tool.
- 5.4.6. Complete your cleaning by wiping the mobile device screen, top to bottom, ensuring that all crevices have been cleaned.
- 5.4.7. Liquid splashes on the front panel can occur with device usage and these should be wiped off as previously described.

6. Troubleshooting & Support

6.1. Mobile Unit Troubleshooting

6.1.1. Low Battery

The user should charge the battery when the low or depleted indicator lights turn orange. Also check if the LED light can be switched on and, if not, charge the battery.

6.1.2. Battery Disconnection

Contact customer service if the battery becomes partially or fully disconnected. If your optical unit is fully charged but the LED light does not turn on, or turns on and off, this may indicate a battery disconnection.

6.1.3. Overheating of Internal Board

If you feel unusual heat while holding the device, please discontinue use and contact customer service as soon as possible.

6.1.4. Defective LED Light

If the LED light won't turn on, make sure that:

The optical unit is fully charged.

Charge the device with the USB cable provided when the bottom indicator light is orange, the device battery is low or the LED light will not turn on. If the cable is not working and the optical unit is not charging, try charging the unit with an alternative USB cable.

If the LED light still does not turn on after charging, contact customer service.

6.1.5. Burned out LED Light

If the LED light is burned out and provides no or low illumination, the user should check to make sure it is switched on. If the battery is charged, and the LED light still does not turn on or provides low light, contact service.

6.1.6. Charge Indicator Lights

Upon system initialization, the indicator lights flash and should blink when the battery is charging. If this does not occur, it may indicate that the LED light has burnt out. In this case, contact customer service.

6.1.7. Optical Unit Casing

If the optical unit casing is cracked or not intact, leading to artifacts in the image or a low-resolution image, contact customer service.

6.1.8. On/off Switch

If the on/off switch is stuck, contact customer service. The optical unit is programmed to timeout the LED light after 30 minutes of operation. If the timeout fails, contact customer service.

6.1.9. USB Connection Ports

If the USB connection ports are broken, contact customer service to replace the optical unit.

6.1.10. Charger

If the device isn't charging as normal, the user should contact customer service.

6.2. Lens Troubleshooting

6.2.1. Lens Cracks or Misalignment

If a cracked or misaligned lens is causing artifacts or low-resolution images, contact customer service to replace the lens.

6.2.2. Dirt on Lens

If dirt on the lens causes artifacts or low-resolution images, the user should clean the lens. If these does not help, contact service to replace the lens.

6.3. Mobile Device Troubleshooting**6.3.1. Low Battery**

If the mobile device battery is low, which may cause the mobile device to shut off during a procedure, the user should charge the mobile device and not continue use until it is sufficiently charged. The mobile device should be charged before the procedure or while the device is not in use as it cannot be used when charging. If the mobile device is charged and continues to turn off, the user should contact customer service.

6.3.2. Overheating

If the mobile device overheats, refer to the Samsung J530 user manual and follow the appropriate instructions, and contact customer service if needed.

6.3.3. Insufficient Memory

Make sure there is enough memory available before starting an exam through the EVA Application, and delete unnecessary files if you need to free up storage space. To learn how to check available memory, refer to the Samsung J530 User Manual. The EVA Application will warn users of low memory and offer to archive patient cases to the Online Portal.

If the user does not want to sync information with the EVA Online Portal, the user should transfer patient cases to localized storage and then manually delete cases from the EVA Application. If the warning persists when there are few or no patient cases, the user should contact customer service.

6.3.4. Cracked Mobile Device Screen

If the mobile device screen is cracked or has been compromised due to a fall or other form of damage, contact customer service.

6.4. EVA Application Troubleshooting**6.4.1. Unresponsive EVA Application**

If the EVA Application freezes and the mobile device is not operational, the user should restart the application, followed by restarting the mobile device, if required. If the problem persists, the user should check that the application is updated. If the EVA Application is updated and still unresponsive, contact customer service.

6.4.2. Unwanted Deactivation

If the mobile device operating system closes the EVA Application due to memory allocation and the device is not operational, the user should restart the EVA Application. If the problem persists, the contact customer service.

6.4.3. Unresponsive Camera

If images can not be taken by the EVA Application or stalled with an unresponsive camera, the user should make sure that no other apps are running on the mobile device.

7. How to Capture a Clinically Useful Image

Clinically useful images are critical for remote consultation, patient documentation, and quality assurance purposes. There are several factors to consider to ensure high quality images.

7.1. Stability

The colposcope should be in a stable position while capturing an image. The unit can be stabilized by:

- 7.1.1. **Using a stand:** The colposcope can be attached to a provided stand. The height of the stand should be the same as the height of the examination table (standard medical table height is 80-110 cm/31.5-43.5 inch).
- 7.1.2. **Using the neck strap:** if you need to take the colposcope off the stand, please be sure to use the neck strap for stability. When holding the unit by hand with a neck strap, please confirm that the neck strap is extended completely. The length of the neck strap can be adjusted for user comfort.
- 7.1.3. **Hand-wave feature:** Images can be captured without touching the screen, through the hand-wave feature. This enables the user to wave their hand in front of the proximity sensor above the visualization screen in order to capture an image.

7.2. Positioning

- 7.2.1. **Distance:** The device should be positioned at a distance of 25-40 cm / 10-15.7 inches from the patient's cervix.

Important: the colposcope should never come into physical contact with the patient.

- 7.2.2. **Angle:** The entire face of the cervix should be captured in the image, without any obstruction by the speculum. The colposcope lens should be aimed directly at the patient's cervix.

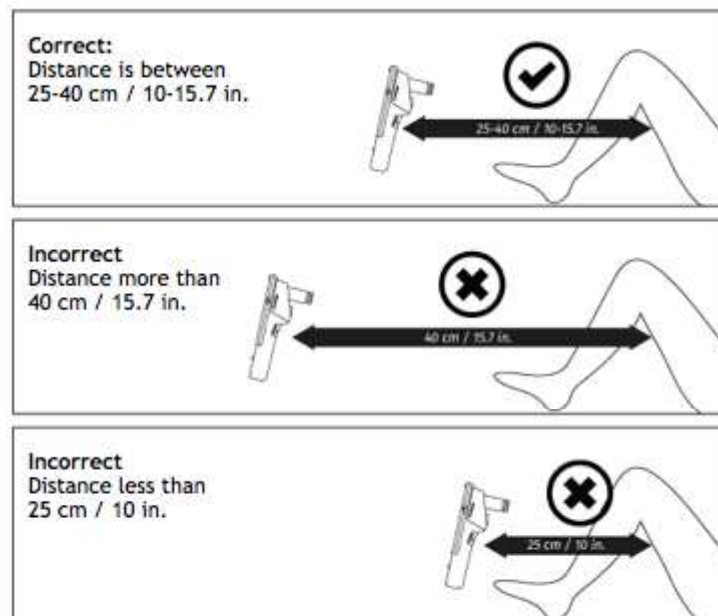

(figure 16)

7.3. Illumination

The cervix should be fully illuminated and without glare.

The LED light is powered by a rechargeable battery contained within the optical unit. The battery has charge capacity sufficient for approximately 10 hours of continual use.

- 7.3.1. The colposcope reduces glare with a polarizer, however glare from the speculum reflection is still possible. If this is the case, reposition the colposcope and/or the speculum until there is less glare.
- 7.3.2. When holding the colposcope, make sure not to block the LED light with your finger.

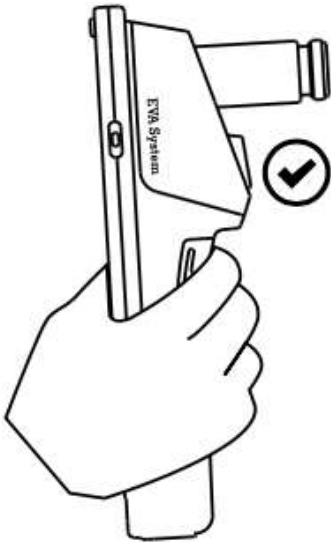

(figure 17)

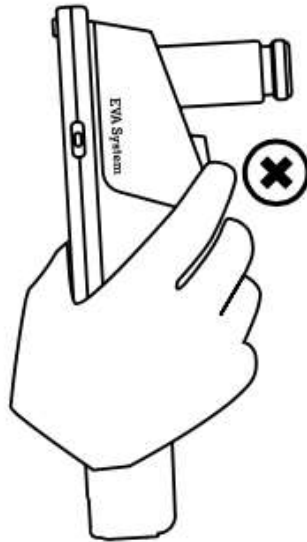

(figure 18)

7.4. Focus

There are two ways to adjust the colposcope focus.

- 7.4.1. The first is to adjust the distance between the colposcope and the patient. Once you have achieved adequate focus, as you zoom in and out digitally you can use the fine focus wheel at the tip of the lens to re-adjust your focus.
- 7.4.2. The recommended default setting for the fine focus wheel is to be fully extended. If working at a distance which normally yields the clearest images doesn't work, you can try adjusting the fine focus wheel so that the lens moves in and out until the correct focus is found.

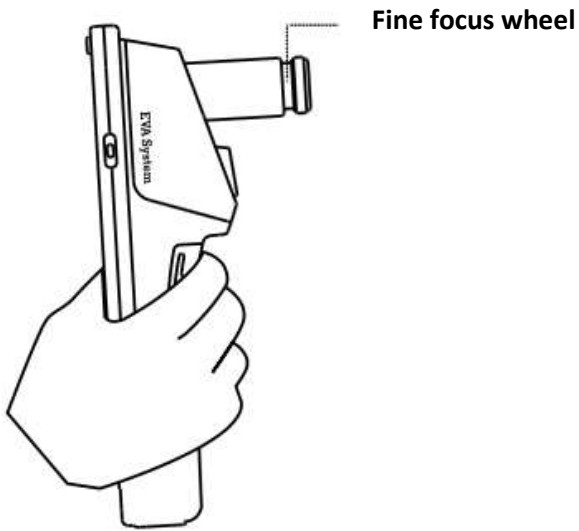

(figure 19)

After you have captured images, it is important to review the images to verify they are clinically useful.

8. Specifications

Item	Specification	Technical Data
Power requirements	Charger Input Voltage	100-240 AC As rated by dual port MicroUSB charger
	Frequency	50/60 HZ, as rated by dual port MicroUSB charger
	Output	5.2V DC
Dimensions	Optical Unit (HxWxD)	24.39 cm x 8.1cm x 10.41 cm (w/lens) 24.39cm x 8.1cm x 6.63cm (w/o lens)
	Lens	93.1mm long x 30mm diameter
Weight	OpticalUnit	345g
	Lens	100g
	<u>Mobile Device</u>	160g
	Total	605g
EVA System specifications (For Samsung J530)	Working distance	250mm – 400mm
	magnification	4.0X optical/16X with digital zoom (at 225mm) 3.8X optical/15X with digital zoom (at 425mm)
	Field of view	53mm (at 225mm) -104mm (at 400mm)
	Depth of field	17mm (at 225mm) - 34mm (at 425mm)
Operating Environment	Ambient temperature	50°F (10°C) to 104°F (40°C)
	Relative humidity	95% max
	Atmospheric pressure	70kPa/10.1psi to 110kPa/16psi
Transportation and Storage Environment	Ambient temperature	-4°F (-20°C) to 104°F (40°C)
	Relative humidity	10% - 70%
	Atmospheric pressure	57kPa/8.3psi to 102kPa/14.7psi
LED light	Lamp type	White LED (color temperature 6000K) with a viewing angle at 50% lv of 120°
	Lamp voltage	3.6V The 2W LED is operated at 1.16W, providing ~289 Lux of luminous flux at a beam angle of 14 degrees
	Polarizer	Linear polarizing laminated film (cross-polarized), wavelength

		range 400-700mm
Use life	Unit battery	10 years

8.1. Electromagnetic compatibility - manufacturer declaration

- 8.1.1. The EVA System requires special precautions in regard to electromagnetic compatibility.
- 8.1.2. It must be installed and prepared for use as described in the Operation section of this User Manual.
- 8.1.3. The separation distances recommended in this paragraph must therefore be complied with.
- 8.1.4. The EVA System must not be used near or on top of another electronic device. If this cannot be avoided, it is necessary – before clinical use – to check the equipment for correct operation under the conditions of use.
- 8.1.5. The use of accessories other than those specified or sold by MobileODT as replacement parts may have the consequence of increasing the emissions or decreasing the immunity of the unit.

8.2. Electromagnetic emissions

- 8.2.1. The EVA System is intended for use in the electromagnetic environment specified in the following tables 1, 2, 4 and 6 below.
- 8.2.2. The user and/or installer of the unit must ensure that it is used in such an environment.

Table 1

Guidance and manufacturer's declaration – electromagnetic emissions – EVA System

The **EVA System** is intended for use in the electromagnetic environment specified below; The customer or the user of the **EVA System** should assure that it is used in such an environment.

Emissions test	Compliance	Electromagnetic environment - guidance
RF emissions CISPR 11	Group 1	The EVA System uses RF energy only for its internal function. Therefore, its RF emissions are very low and are not likely to cause any interference in nearby electronic equipment.
RF emissions CISPR 11	Class B	The EVA System is suitable for use in all establishments, including domestic establishments and those directly connected to the public low-voltage power supply network that supplies buildings used for domestic purposes.

Table 2

Guidance and manufacturer's declaration – electromagnetic immunity – EVA System

The **EVA System** is intended for use in the electromagnetic environment specified below; the customer or the user of the **EVA System** should assure that it is used in such an environment.

Immunity test	IEC 60601-1-2 Test level	Compliance level	Electromagnetic environment - guidance

EVA System User Manual

No. 10-LB-038

Rev.05

Electrostatic discharge (ESD) IEC 61000-4-2	8 kV contact 15kV air	8 kV contact 15 kV air	Floors should be wood, concrete or ceramic tile. If floors are covered with synthetic material, the relative humidity should be at least 30 %.
Power frequency (50/60 Hz) magnetic field IEC 61000-4-8	30 A/m	30 A/m	Power frequency magnetic fields should be at levels characteristic of a typical public low-voltage power supply network that supplies buildings used for domestic purposes, commercial or hospital and clinical environments.

Table 4

Guidance and manufacturer's declaration – electromagnetic immunity – EVA System

The **EVA System** is intended for use in the electromagnetic environment specified below; the customer or the user of the **EVA System** should ensure it is used in such an environment.

Immunity test	IEC 60601-1-2 Test level	Compliance level	Electromagnetic environment - guidance
Radiated RF IEC 61000-4-3	10 V/m 80 MHz to 2.5 GHz	10 V/m	<p>Portable and mobile RF communications equipment should be used no closer to any part of the EVA System, including cables, than the recommended separation distance calculated from the equation, applicable to the frequency of the transmitter.</p> <p>Recommended separation distance</p> $d = \sqrt{P/EVP} \quad 80 \text{ MHz to } 2.5 \text{ GHz}$ <p>where P is the maximum output power rating of the transmitter in watts (W) according to the transmitter manufacturer and d is the recommended separation distance in meters (m) and E is the immunity test level in V/m.</p> <p>Field strengths from fixed R F transmitters, as determined by an electromagnetic site survey,^a should be less than the compliance level in each frequency range.^d</p> <p>Interference may occur in the vicinity of equipment marked with the following symbol:</p>



NOTE 1 At 80 MHz and 800 MHz, the higher frequency range applies.

NOTE 2 These guidelines may not apply in all situations. Electromagnetic propagation is affected by absorption and reflection from structures, objects, and people.

a. Field strengths from fixed transmitters, such as base stations for radio (cellular/cordless) telephones and land mobile radios, amateur radio, AM and FM radio broadcast, and TV broadcast cannot be predicted theoretically with accuracy. To assess the electromagnetic environment due to fixed RF transmitters, an electromagnetic site survey should be considered. If the measured field strength in the location in which the **EVA System** is used exceeds the applicable RF compliance level above, the **EVA System** should be observed to verify normal operation. If abnormal performance is observed, additional measures may be necessary, such as re-orienting or relocating the **EVA System**.

b. Over the frequency range 150 kHz to 80 MHz, field strengths should be less than 3 V/m.

8.3. Recommended separation distances

The **EVA System** is intended for use in an electromagnetic environment in which radiated radio frequency disturbances are controlled.

The user and/or installer of the unit can help prevent electromagnetic interference by maintaining a minimum distance between portable and mobile radiofrequency communications equipment (emitters) and the **EVA System**, according to the maximum output power of the equipment, as recommended in the table below.

Table 6

Recommended separation distances between portable and mobile RF communications equipment and the EVA System

Rated maximum output power of transmitter Watts [W]	Separation distance according to frequency of transmitter (in meters)	
	Meters [m]	
	80MHz to 2.5GHz	
	$d = 6/\sqrt{P}$	
0.01	0.06	
0.1	0.19	
1	0.6	
10	1.90	
100	6	

For transmitters rated at a maximum output power not listed above, the recommended separation distance d in meters (m) can be estimated using the equation applicable to the frequency of the transmitter, where P is the maximum output power rating of the transmitter in watts (W) according to the transmitter manufacturer.

NOTE 1 At 80 MHz and 800 MHz, the separation distance for the higher frequency range applies.

NOTE 2 These guidelines may not apply in all situations. Electromagnetic propagation is affected by absorption and reflection from structures, objects, and people.

9. Replacement parts and technical service

Technical service

When contacting our Service and Repair department, you will need to provide the following information:

Details on the defect that has occurred and the corresponding serial number of the EVA System colposcope. These can be found on the label located on the back of your unit.

For further support, please contact support@mobileodt.com.

MobileODT, LTD. Ben Avigdor 8, Tel Aviv, Israel
support@mobileodt.com
+1-617-454-4687
www.mobileodt.com

Entering the portal

Enter the EVA Portal by entering the following link in your browser: **www.eva.mobileodt.com**

The supported browsers are the latest versions of: Chrome, Firefox, Safari and Edge

Software

10. EVA Portal**10.1. Welcome screen**

You will be presented with the Welcome screen. Here you can:

- Set up - for new users (refer to section 3)
- Log in - for existing users (refer to section 4),
- Reset your password - by pressing “Forgot password?” (refer to section 5)
- Contact MobileODT (refer to section 8).
- Review our terms and conditions, as well as our privacy policy.

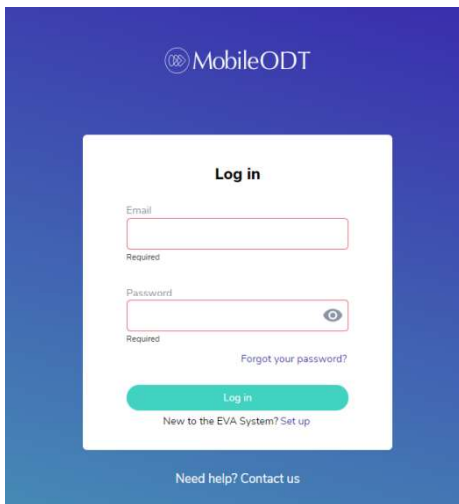
**10.2. Setting up a user**

10.2.1. If you are new to the EVA System and did not set the password on an EVA device or on the portal click on “Set up.”

10.2.2. Enter the email associated with your EVA user account.

- 10.2.3. Click on 'Send activation code.'
- 10.2.4. An email will be sent with a code that needs to be entered in the next screen.
- 10.2.5. Enter the activation code you received.

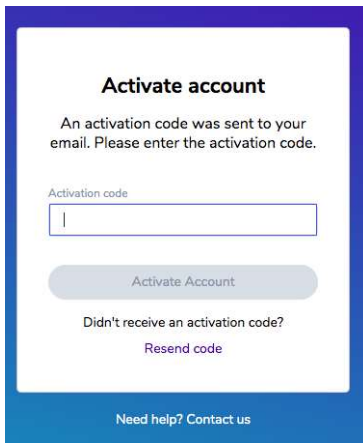

- 10.2.6. If you did not receive an email check your spam and trash folders.
- 10.2.7. After entering the activation code you will be requested to select a password.
- 10.2.8. The password requires a minimum of eight characters including a capital letter, a lowercase letter, one number and one special character. This password will be used to access your EVA account, both on the portal and on EVA devices.

10.3. Logging in

- 10.3.1. If you have already set up your EVA user and have chosen a password in the system press 'Log in'.

- 10.3.2. Enter the email and password for the EVA System (the same used in the EVA device to create your EVA account).

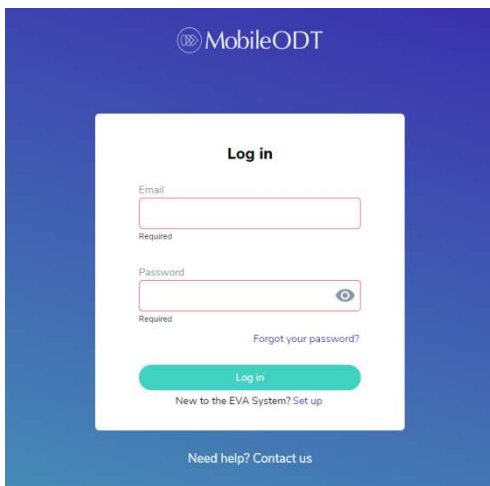

10.4. Forgot password

- 10.4.1. Click "Forgot password?" on the welcome screen

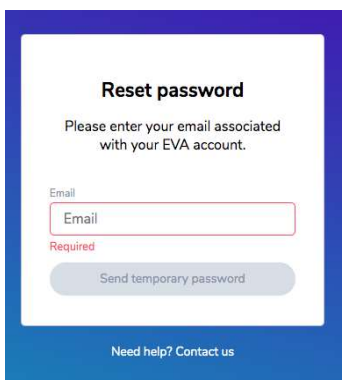

- 10.4.2. Enter the email address associated with your EVA account
- 10.4.3. An email will be sent to the email entered with a temporary password
- 10.4.4. Enter the temporary password and create a new one, then enter it once again

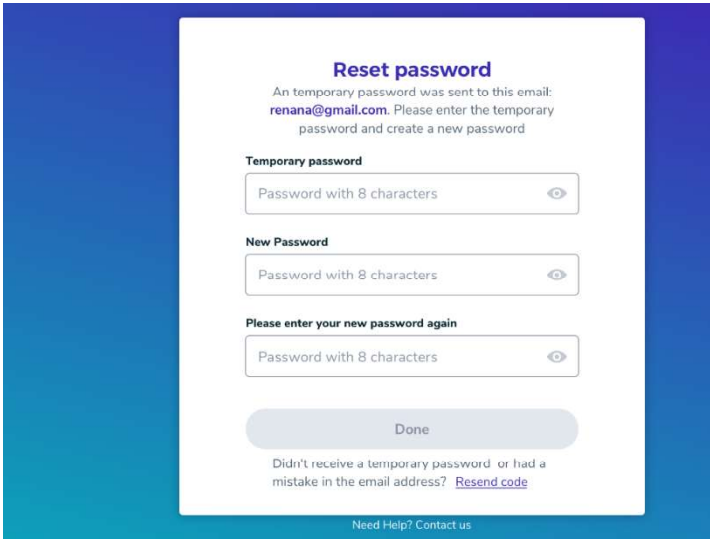

10.5. ReCaptcha after failed login attempts on EVA Portal

- 10.5.1. If a user has made 5 failed attempts to login, then on the sixth attempt they must complete a reCapture form to verify that they are not a robot.
- 10.5.2. Once the reCapture is successful, they can then proceed to log in as normal.

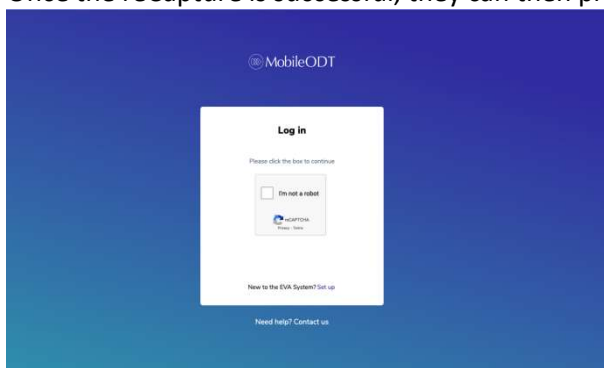

10.6. Limitation of active logins

There is a limit of 10 active connections to the EVA System (either to multiple EVA devices or to the EVA Portal from multiple locations) that can be maintained by one user.

10.7. Viewing patient records

Upon successful login, you can view a list of all the cases you have performed with the EVA System with exam notes.

- 10.7.1. To review a patient’s exam note click on the name of the patient in the list.

10.7.2. Deleting a patient record: hover the cursor over a patient name, and a delete button is displayed in the right column. When the deletion is confirmed all the data related to the patient is permanently deleted from the system.

10.8. Searching for patient records

10.8.1. To search for a patient, enter the patient name or medical record number by typing in the search field at the top of the screen and tapping enter. The relevant results will be presented on the screen.



10.9. Reviewing and editing patient examination records

10.9.1. In the patient examination record, all the information collected about the patient during current and past examinations is displayed: patient details, documentation of the exam, images, annotations and history of present illness

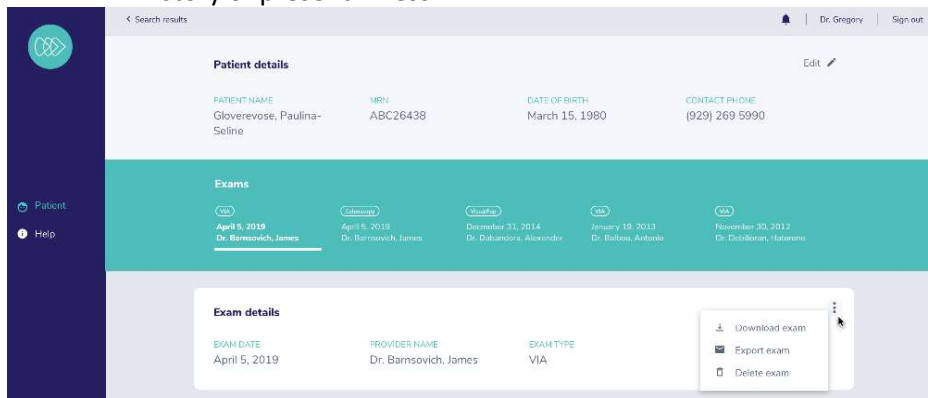

10.9.2. If multiple examinations of the same patient have been collected, they will be shown on the top of the patient examination record. The user can choose to view the specific examination by clicking on the date of the examination.

10.9.3. An option to delete an exam is displayed next to exam details. Once it's confirmed all the exam's data is permanently deleted from the system.

10.10. Editing the Exam

10.10.1. In the patient examination record, the user can edit the documentation section and the history of present illness by pressing the edit icon.



10.10.2. When the user on the edit icon in the patient record, a modal with all the relevant information appears and the user can change the field. To save the changes, the user needs to press on “Save”.

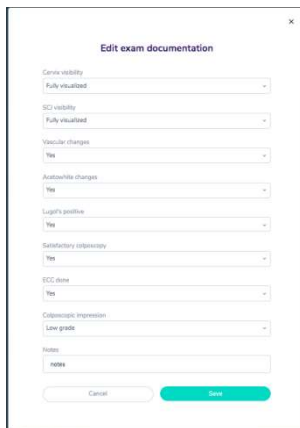

10.11. Viewing images and annotations

10.11.1. Viewing images: in the patient examination record, the user can open a large size version of any image by clicking on the thumbnail of that image.

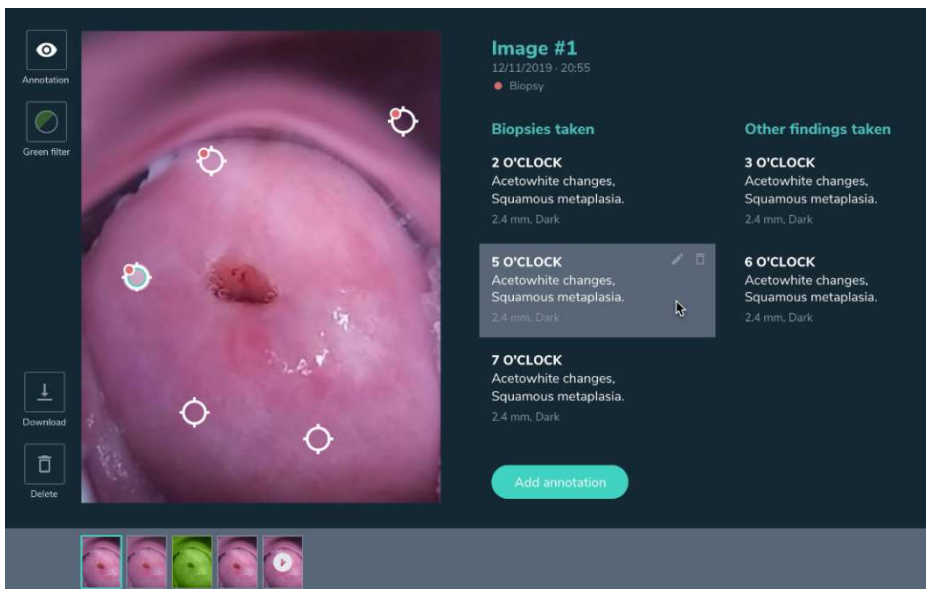

- 10.11.2.** Deleting images: in the patient examination record, the user can select several images to delete. After selecting the images click on the “Delete” icon at the top right and confirm to delete the images. Once it’s confirmed all the selected images are permanently deleted from the system.

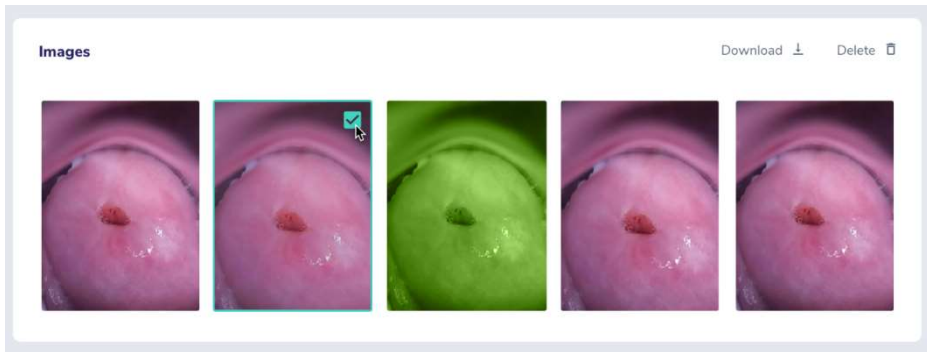

- 10.11.3.** In the image gallery view, the user can delete the specific image by pressing the ‘Delete’ button in the left bottom corner. Once it’s confirmed the image is permanently deleted from the system.

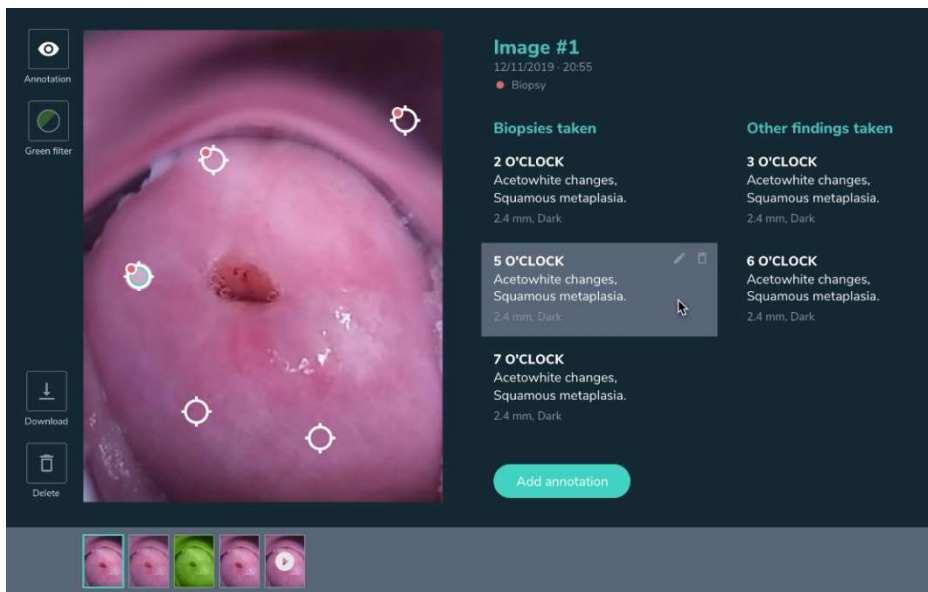

- 10.11.4.** In order to switch between images, the user can either press on the thumbnails below the large image to jump directly to that particular image, or use the arrows on both sides of the screen to navigate through the images
- 10.11.5.** Download image – the user can download an image by pressing the ‘download’ button.
- 10.11.6.** Show/Hide Annotations - By clicking on the annotation button on the top left of the screen, users can view or hide any annotations that were made on that particular image. Annotation description/notes are displayed on the right-hand side of the screen. Locations of annotations are shown on the image.
- 10.11.7.** Add annotation – by pressing ‘Add annotation’, the user can add annotation to every image in the exam. The following fields are needed to be filled: annotation position, biopsy taken, diagnosis and additional notes.
- 10.11.8.** Edit/Delete annotation – when the user’s mouse is on a specific annotation, the delete and edit buttons are displayed. To edit the particular annotation, the user can press the ‘edit’ button. To delete an annotation, the user can press the ‘delete’ button.

- 10.11.9. View Green filter - While in large image view, a user can also apply the green filter to that image. The green filter can be applied or removed by pressing the green filter button at the top left side of the screen.
- 10.11.10. High contrast filter - a user can apply a high contrast filter that highlights areas of vascularity. The high contrast filter can be applied or removed by pressing the high contrast filter button.
 - 10.11.10.1. This feature is available only for exams taken in SANE clinical scenario.
 - 10.11.10.2. It can be configured on the camera settings menu.
 - 10.11.10.3. Whenever it is turned on, it can be found on the capture screen instead of the green filter button.
- 10.11.11. To close the large size image, the user should press the X button on the top right corner.

10.12. Adding notes

- 10.12.1. The user can enter free notes and view them in the examination record.

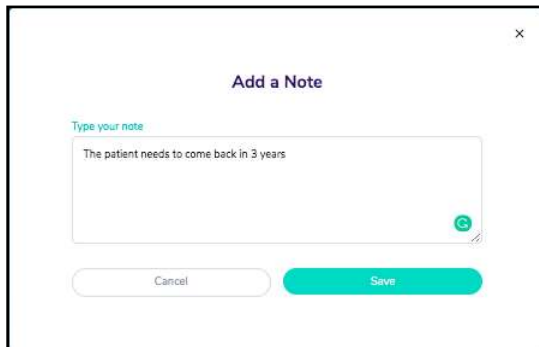

- 10.12.2. To enter a new note, the user needs to click on “Add note” button and a pop up is displayed where the user enters free text and press Save. The new note will appear in the notes section.

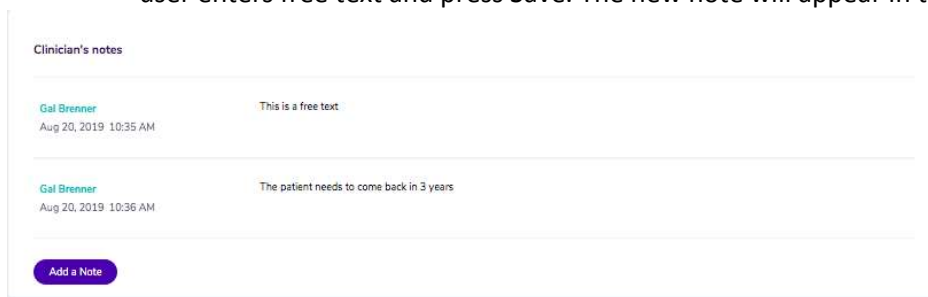

10.13. Help

- 10.13.1. The help button allows you to send a support request to the MobileODT support team. Enter all the details requested on the support form that opens.

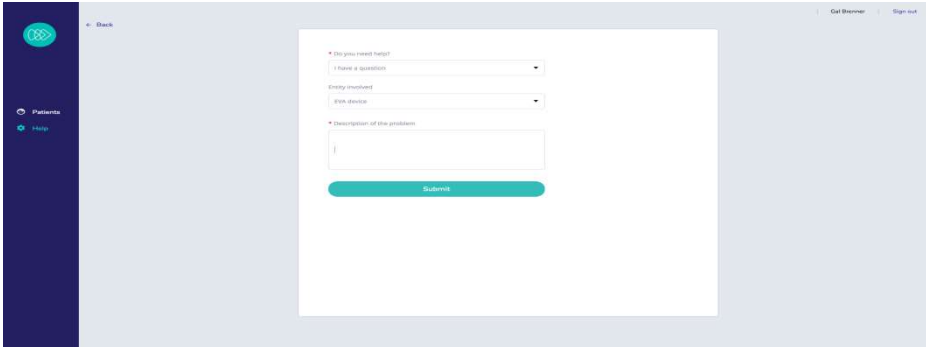

10.14. Export & Download

10.14.1. Export to PDF

10.14.1.1. In the exam page the options to export or download a pdf is available

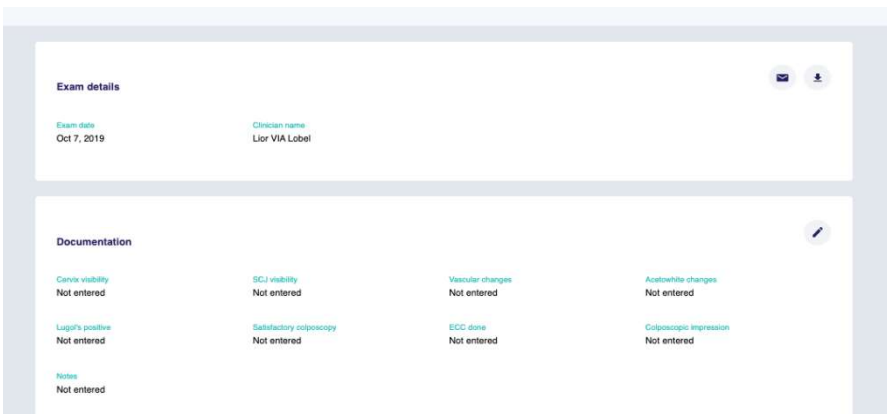

10.14.1.2. A 6 digit PIN code is requested to ensure the PDF file of the examination will remain secure. The PIN cannot be sequential, and an individual digit cannot be repeated more than 3 times.

10.14.1.3. After setting the pin, the PDF will be sent to the user's email or downloaded to the computer.

10.14.1.4. In order to view the exam PDF file, the user will need to enter the code he had previously selected.

- *Option 1- Export exam to email:*

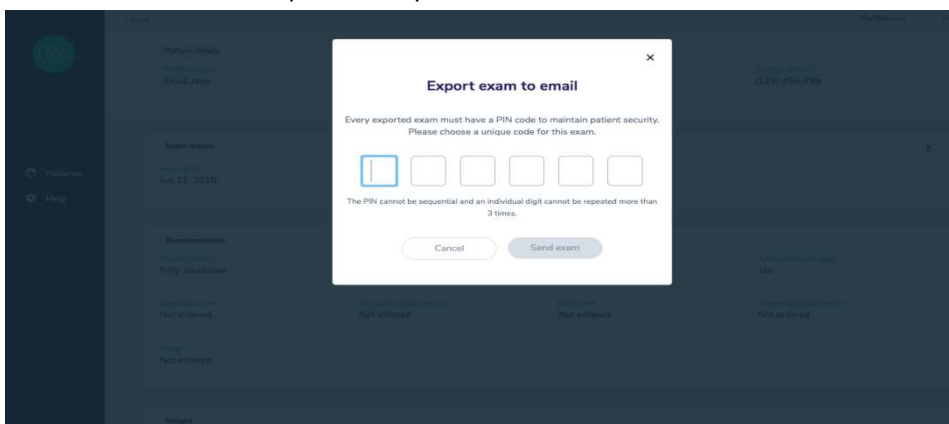

Upon choosing this option, the user will receive a link to his email from which the exam can be downloaded

- Option 2- Download exam:

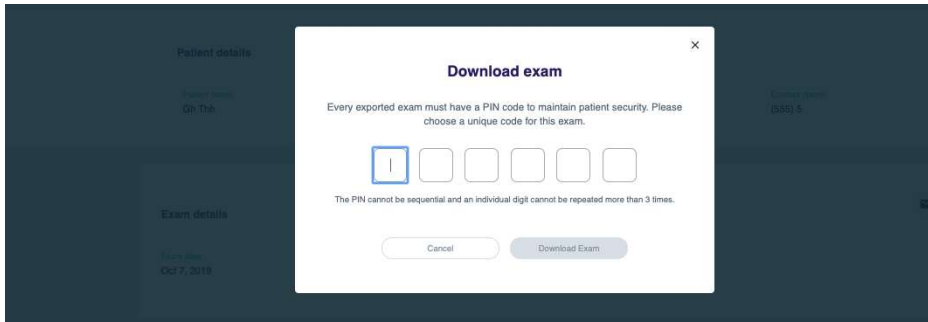

Upon choosing this option, the user will be able to choose to download only the exam’s report as PDF, or the PDF along with the exam’s media files

10.14.2. Add logo to PDF

Clinical admins can add a personalized logo to exported pdf exam report.

- 10.14.2.1. When viewing the patient details, select ‘Add pdf’ from the settings menu

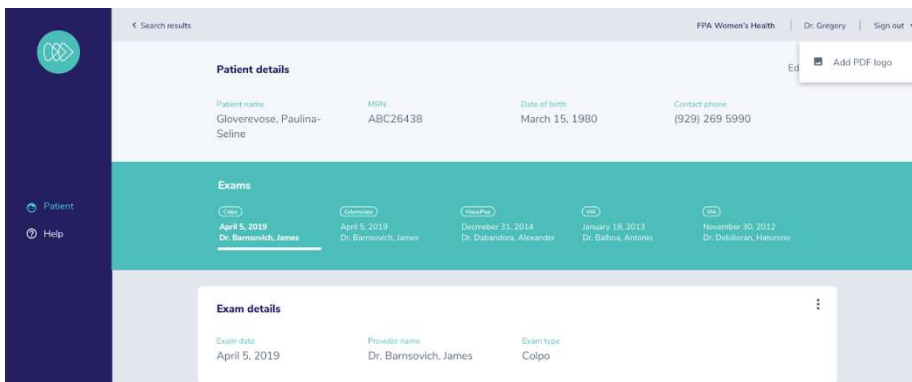

- 10.14.2.2. Then either drag and drop, or browse the local computer for your selected file and upload to the EVA Portal. Click ‘add logo’ to attach the selected logo to the pdf for export.

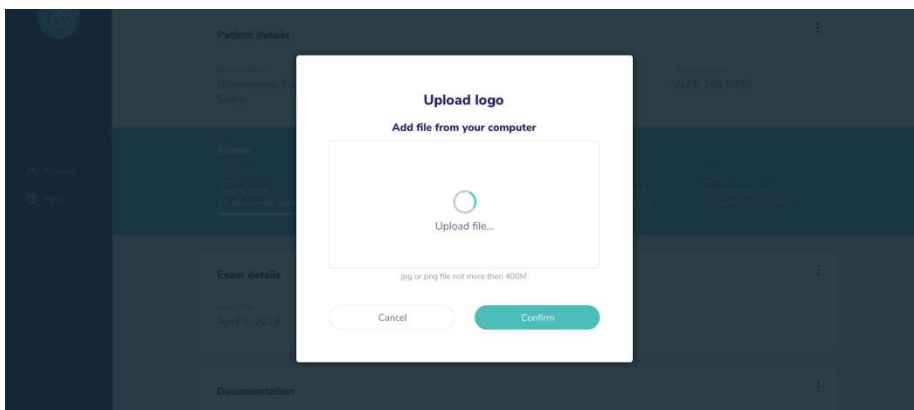

- 10.14.2.3. Image files must be no more than 4MB and in jpg or png format.

- 10.14.2.4. Click confirm to have this logo automatically added to any future pdf reports

10.14.3. Download all exams (Bulk Download)

- 10.14.3.1. At the top right of the patient menu there is an option to bulk download all exams created by you.

This will enable you to download all exam data that exists within your entire EVA System account.

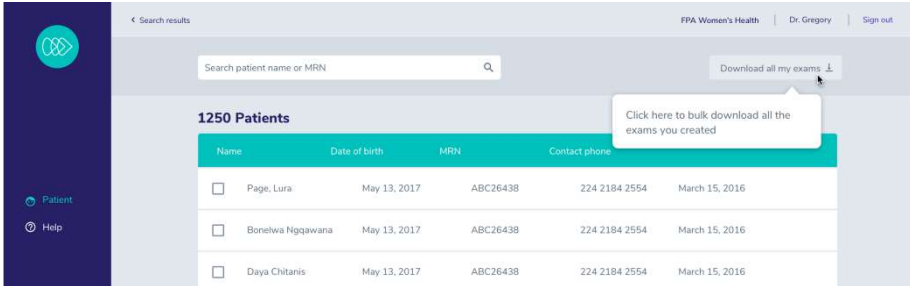

- 10.14.3.2. The bulk download feature will send a request to MobileODT’s servers to export all of your data in encrypted files. Processing the request may take between several minutes to hours.
- 10.14.3.3. Once the processing is complete, an email will be sent to your account with a link that includes all the data you have as an encrypted ZIP file. The links are encrypted with a PIN code and will be available for 72 hours.
- 10.14.3.4. Each Zip file contains a CSV file, which lists all the exported data that exists within the Zip file, and a folder containing each exam as a separate file (PDF report and media files).
- 10.14.3.5. Along with links to the ZIP files, you will also receive a link to a CSV file with a summary of all downloaded exams. This summary is a content list indicating on which ZIP file each exam exists, and if it was downloaded successfully. If an exam were not downloaded, it is still available to download manually from the portal.
- 10.14.3.6. Each download request requires a 6-digits PIN. You will be promoted to create a PIN for that download. This PIN will be used to open all encrypted ZIP files.
- 10.14.3.7. Bulk download can be generated once every 24 hour period.

11. EVA System software application

11.1. Setting Up a New User

11.1.1. Enter the EVA app

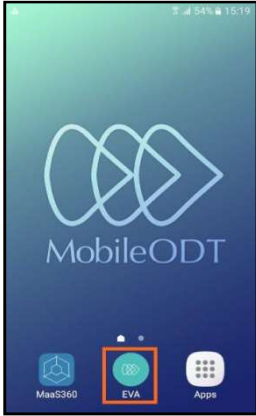

11.1.2. Tap on set up

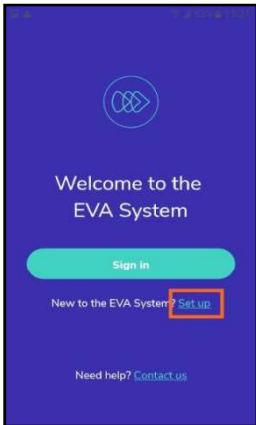

11.1.3. Enter the email address that was used to create your EVA account.

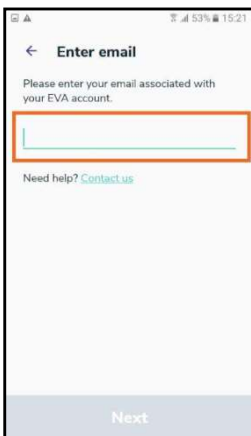

11.1.4. Tap on 'Next'

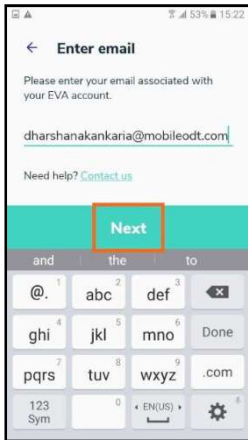

11.1.5. An email is sent to that address with an activation code that needs to be entered in the next screen. tap on 'Enter code'

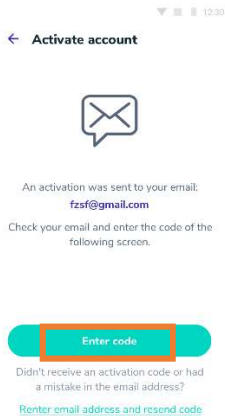

11.1.6. Enter the activation code you received in your email and tap on 'Next'. An example for such an email:

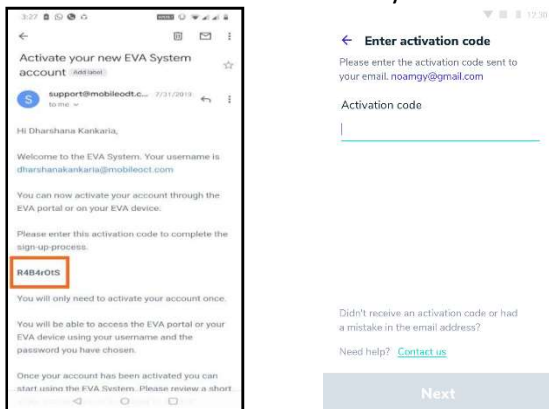

11.1.7. Set a password - the password requires a minimum of eight characters including a capital letter, a lowercase letter and one number. tap on 'Next'. This password will allow you to access the EVA System including the EVA portal.

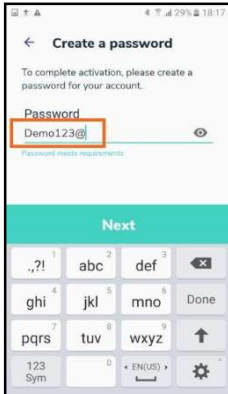

11.1.8. Create 6 digit secure PIN. The PIN will give you secure access to this particular EVA device. tap on 'Save PIN'.



11.1.9. Read and accept the terms of use before using the app. Click on ' I Agree '

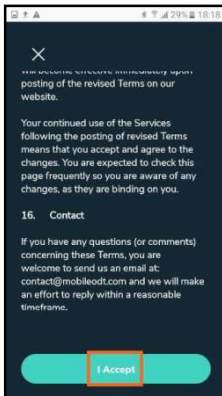

11.1.10. You will be directed to the login page. Enter your PIN to enter the application.

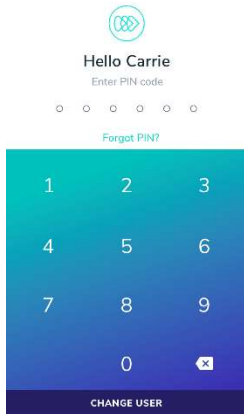

11.2. Log in (existing user)

11.2.1. Tap 'Log in'.

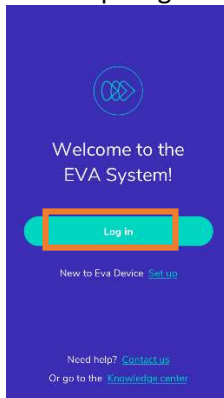

11.2.2. Enter email and password for the EVA System. tap on 'Next'.

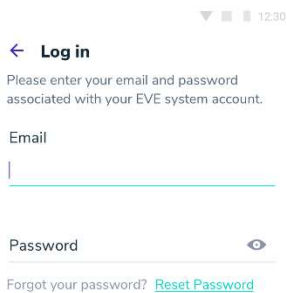

11.2.3. Log in with PIN/Password while online or offline

11.3. reCaptcha after failed login attempts on EVA device

11.3.1. If a user has made 5 failed attempts to login, then on the sixth attempt they must complete a reCapture form to verify that they are not a robot

11.3.2. Once the reCapture is successful, they can then proceed to log in as normal.

11.4. Global sign out

11.4.1. There is a limit to the number of active connections to the EVA System (either to multiple EVA devices or to the EVA Portal from multiple locations) that can be maintained by one user.

- 11.4.2. When a user attempts to initiate a tenth active connection, they are required to log out from all active sessions (global logout)
- 11.4.3. Having logged out from all active sessions, they can then log back in as normal

11.5. Reset PIN

- 11.5.1. If the user that is presented is yours, enter the PIN to access the device. You will have 5 attempts to enter the PIN correctly. If you do not remember the PIN, tap on 'Forgot PIN?' and it will redirect you to the 'sign-in 'screen'. On this screen, you will be able to log in using your email and password.

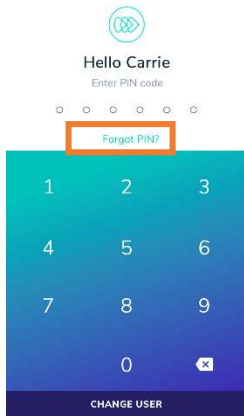

11.6. Changing the user

- 11.6.1. If the user that is presented on the screen is not your user, tap on 'Change user'.

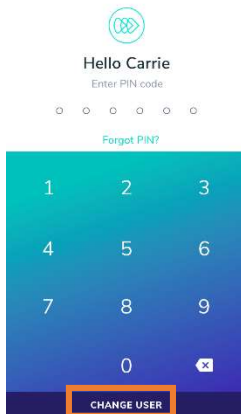

- 11.6.2. The app shows all the users that were added to that particular device. If your email is not in the list tap on 'ADD AN ADDITIONAL USER', and it will redirect you to the sign-in/set up screen'.

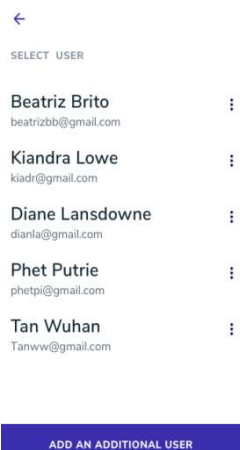

11.6.3. If you wish to remove a user from the device you can press the menu button (three dots) next to the specific user and then select “Remove user”.

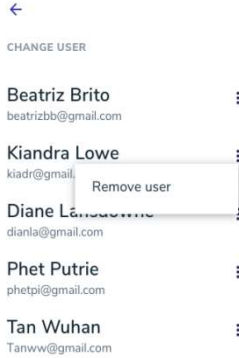

11.6.4. Once it's pressed a confirmation pop-up is displayed.

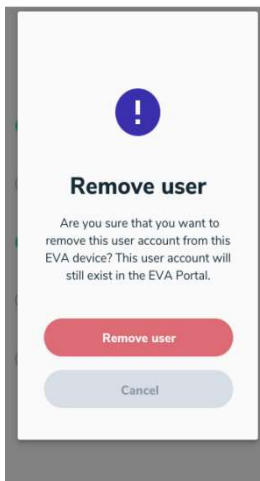

Please note: The user in question is only removed from this particular device. All the data that this user had created is available through the EVA Portal. The user will still be present on any other EVA device that they may have logged into. This user can also add his/her account to this device again in the future.

11.7. Reset EVA account password

A User’s EVA account password can be reset through initial log in menu:

11.7.1. Tap on ‘Log-In’ and then ‘Reset password’.

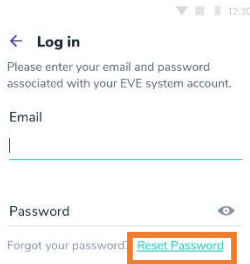

11.7.2. Enter your email address associated with your EVA account and tap on 'Next'.

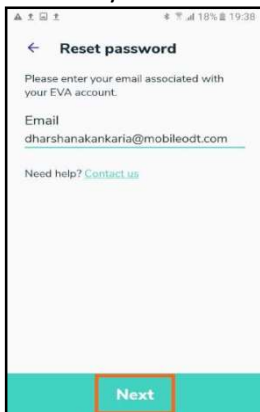

11.7.3. A temporary password will be sent to the email (in this example, fzsfg@gmail.com). Tap on 'Next'.

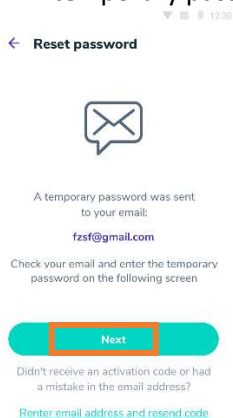

11.7.4. Enter the temporary password in the dedicated field. Enter a new password in the dedicated field. The password requires a minimum of eight characters including a capital letter, a lowercase letter, and one number and one special character. Re-enter the password and Tap on 'Next'.

.]]

11.8. Opt-out status

11.8.1. A user or organization may choose to operate in 'Opt-out' status, meaning that none of their exam data will be uploaded or synced to the EVA Portal online storage.

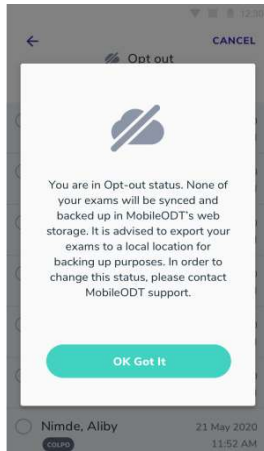

- 11.8.2. Opt-out status is managed by MobileODT administration. Users can request that opt-out status be applied or removed from their account by contacting support@mobileodt.com
- 11.8.3. While in opt-out mode the app is not synced with the EVA Portal and cannot link past exams conducted on a patient with the same MRN.
- 11.8.4. It is advised that exam data be regularly manually exported using USB and backed up on a local computer (see section 14 for instructions)

11.9. Notification Center

- 11.9.1. Users will be notified through the notification center of important information intended to maintain smooth running of their EVA System, such as when a software update is available.
- 11.9.2. Users are alerted that they have unread notifications when they open the EVA device, by a red dot appearing on the Main menu icon on the top left

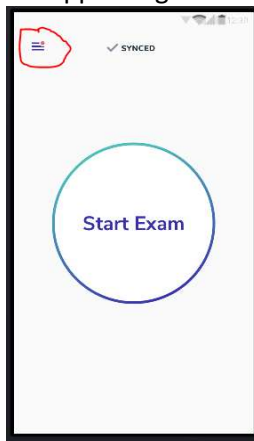

- 11.9.3. When they enter the Main menu, an alert appears next to the Notification listing.
- 11.9.4. To read notifications, click on the Notification listing in the main menu.

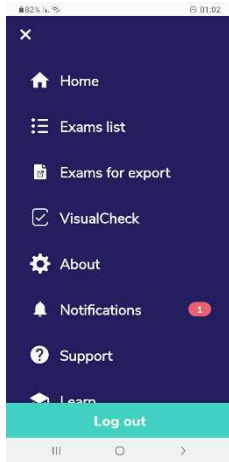

11.10. Performing an exam

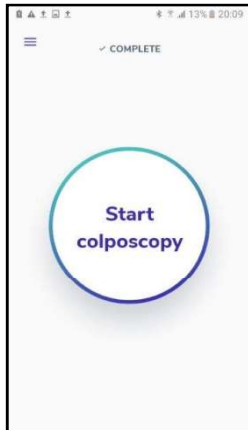

11.10.1. Enter identifying patient information

For each patient, you can enter the following fields: Medical Record Number (MRN), first name, last name, date of birth (or age if date of birth is unknown,) and a contact phone number.



11.10.2. If a medical record number is entered, the subsequent fields can be skipped.

11.10.3. If no medical record number was entered, first name, last name, and date of birth will be mandatory.



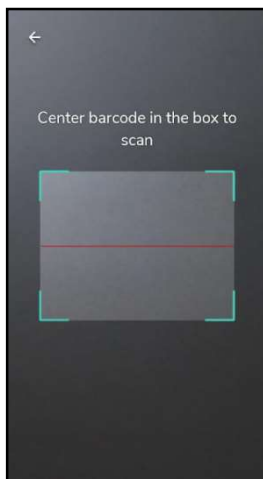

- 11.10.4. MRN can be entered manually or by scanning the barcode by tap oning ‘Scan patient label’.
- 11.10.5. Please note that at this stage you need to hold the barcode in-front of the top of the screen, and not the lens.

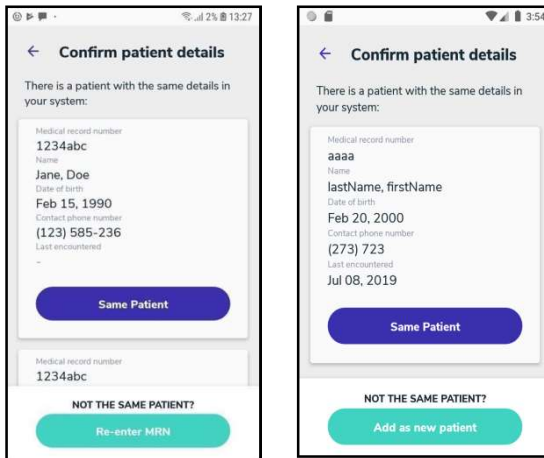

- 11.10.6. If the MRN or the same combination of first and last names with the same date of birth already exists in the user’s account, the system will ask the user if the new patient they entered is the same patient that already exists.
- 11.10.7. The user can either click ‘Same patient’ to add the new exam to the existing patient record, or click ‘Re-enter MRN’ or ‘Add as new patient’ if it is not the existing patient.
- 11.10.8. Please contact Customer Support if there appears to be an issue with the details of an existing patient.

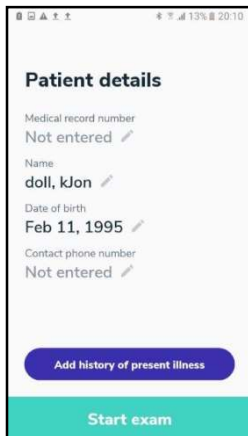

11.10.9. A summary of all entered information will be displayed with an option to edit every field.



11.11. Capture images

11.11.1. In the summary (section 6.4) tap on 'Start exam' and the visualization screen will be displayed.

11.11.2. Follow these steps to ensure you are capturing clinically-useful and focused images:

- Ensure the device light source is turned on.
- Ensure the fine focus wheel found at the tip of the lens is turned all the way out.
- Adjust the device at the appropriate working distance from the patient (typically between 22-42 cm).
- Adjust the fine focus wheel to achieve optimal focus.

11.11.3. Pinch in or out with your fingers on the screen to zoom in and out

11.11.4. To use the green filter, tap on the green button the bottom right.

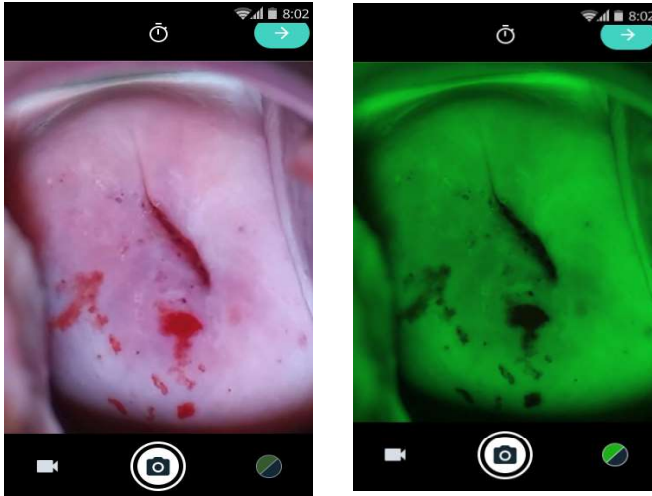

- 11.11.5. After applying acetic acid it is recommended to use the timer. After applying acetic acid to the cervix, tap on the stopwatch icon at the top of the screen. A countdown of one minute will start. After one minute another countdown of four minutes will start. It is advisable to take and capture images and biopsies within this 4 mins window of time.

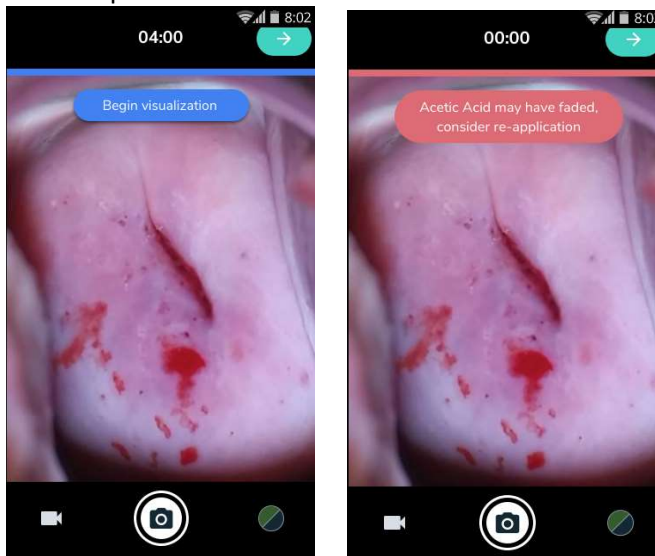

- 11.11.6. Capture images by taping the capture button on the bottom middle of the screen



- 11.11.7. You can also capture images without touching the device screen. To do that: move the hand in a hi-five motion towards the MobileODT logo at the top of the device above the screen. You don't need to touch the device when doing so.
- 11.11.8. When you finish capturing images to your satisfaction, tap on the green arrow button at the top right of the screen and you will be redirected to the image gallery.
- 11.11.9. Capture videos by tapping the video camera button at the bottom left of the screen.

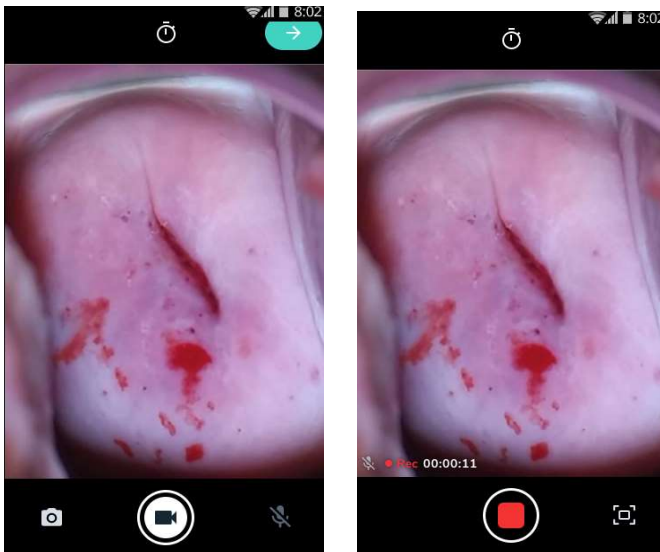

- 11.11.10. You can also capture images while recording by pressing the button at the right bottom of the screen.
 - 11.11.11. If you are under a demo or distributor account, you can take only 3 images and 1 video.
- 11.12. Changing settings during an exam (Camera menu)**
- The camera's settings can be managed directly during an exam by accessing the camera menu
- 11.12.1. The camera menu can be opened by clicking the settings button found on the top of the image capture screen.
 - 11.12.2. To switch a feature on or off click on the toggle button to the right of each feature.
 - 11.12.3. Depending on your clinical scenario, a number of settings may be available,
 - Capture mode
 - Green Filter
 - High contrast filter
 - Quality Frame
 - Hands-free image capture

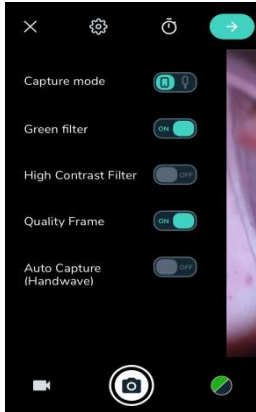

11.13. Review media files

11.13.1. The files that were captured are displayed in the order in which they were taken - from first to last.

11.13.2. Swipe with your finger to the left to see the next file and swipe to the right to see the previous file.



11.14. Add annotations

11.14.1. To annotate an image, tap the location on the image you would like to annotate, and follow the suggested options to record the relevant details.

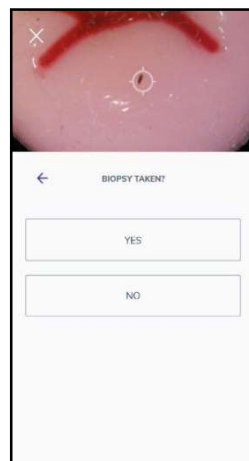
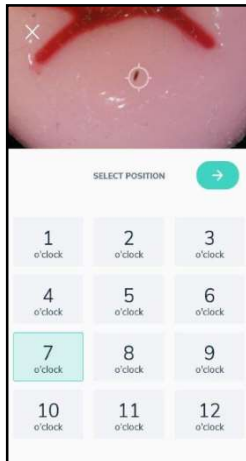

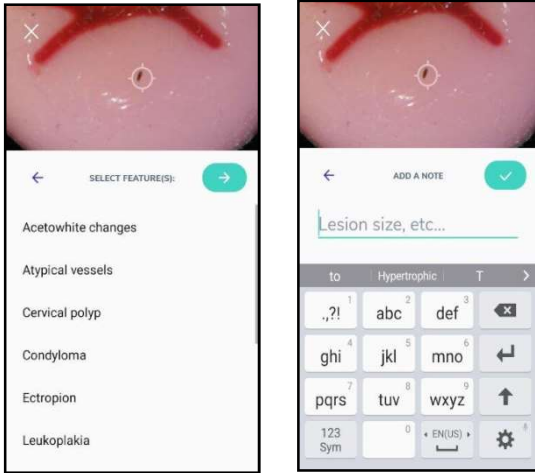

11.14.2. To edit an annotation, tap on the annotation and tap on edit, following the suggested options to edit the relevant details.

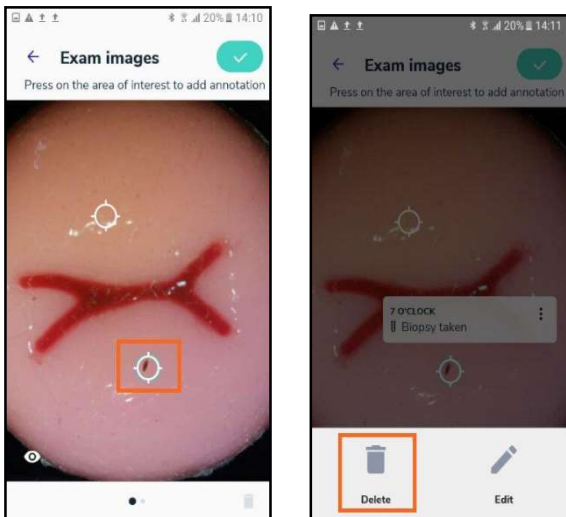

11.14.3. To delete an annotation tap on the annotation and tap on delete. A warning confirming that you want to delete that annotation is shown.

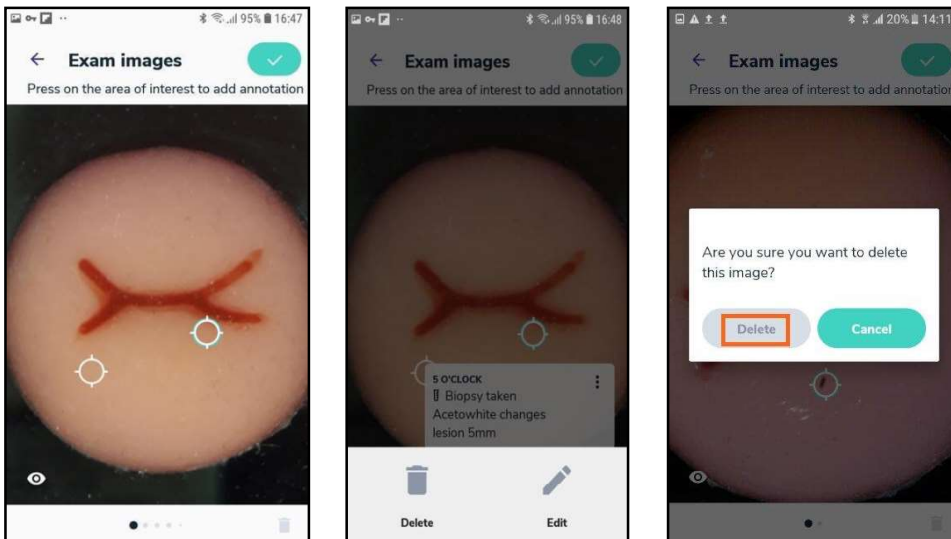

11.14.4. After all the data is entered tap on the green button at the top right of the screen.

11.15. Summary

All the information entered is displayed on the summary page.

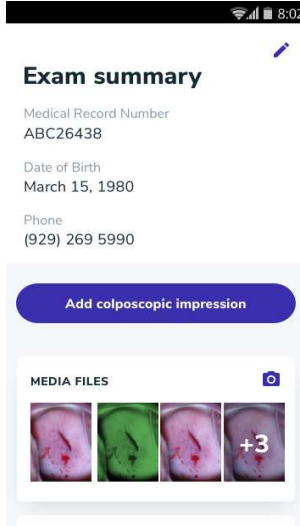

11.15.1. You can edit patient's details by pressing the edit button at the top of the screen.

11.15.2. To finalize the documentation, tap on 'Finish exam' when done. The exam will start uploading to the EVA Portal. The exam will be available for further editing on the device for the next 24 hours.

11.16. Exporting the exam

11.16.1. After tapping on 'Finish exam', an option to export the exam is available. The user can choose between exporting to an email or to a folder on the device from which the exams can be exported and backed up manually on a local drive

11.16.2. Tap on the button 'Export exam'.

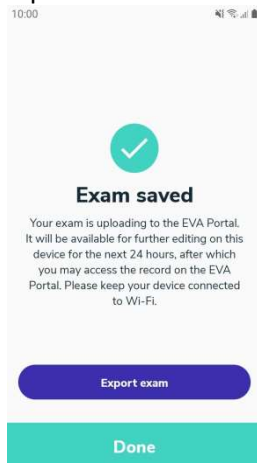

11.16.3. A 6 digit PIN code is requested to ensure the files of the examination will remain secure. The PIN cannot be sequential and an individual digit cannot be repeated more than 3 times.

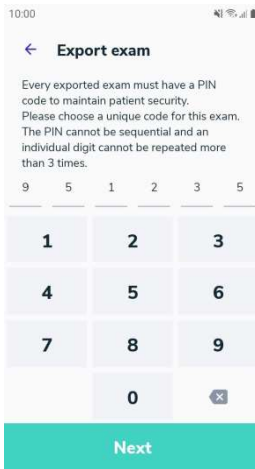

- 11.16.4. After setting the pin, the user will need to choose whether to export to the user’s email or to export to a folder.



- 11.16.5. Upon choosing ‘Export to my email’, the system will start exporting the examination report as a PDF. When the upload process to the portal is completed, the exam will be sent to the user’s email.
- 11.16.6. Upon choosing ‘Export to folder’, the system will start exporting the examination report and media as a ZIP. When the zip is created, the exam will appear on the ‘Exams for export’ page.

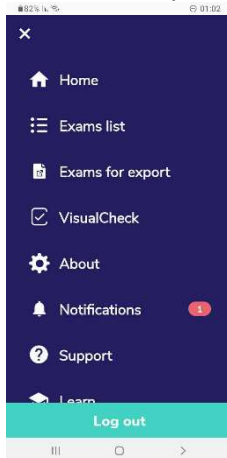

- 11.16.7. If you don’t want to export the exam, tap on ‘Done’ and the home screen will be displayed.

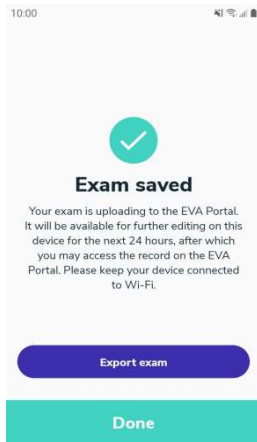

11.16.8. Exams can also be selected for export via the Exam list screen on the main menu. See section 15 for details. Only exams that have been completed can be exported.

11.17. Back up exams on a local drive:

11.17.1. The 'Exams for export' page can be reached from the main menu and presents a list of all exams that exist on the device as ZIP files that are ready to be exported manually and backed up.

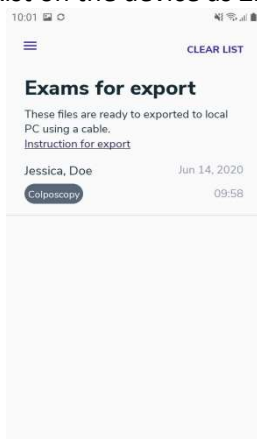

11.17.2. The 'Instructions for export' explain what should be done in order to export the exams from the device using a USB cable



11.17.3. In order to clear this list, which will clear up space in the external folder of the device, the user should click the 'Clear list' button

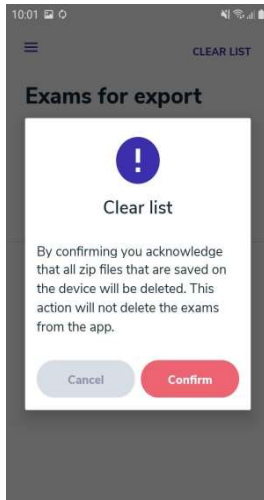

11.18. Limited storage preventing export

- 11.18.1. If the internal EVA Device storage is at maximum capacity, then it will not be possible to export any more files to ZIP format until the storage is cleared and more space available. In this case, a warning popup will be displayed advising the user to return to either the Exams for export or Exam lists and delete exams.
- 11.18.2. It is advisable to remove exams in ZIP format from the device after they have been manually exported via USB to a local computer to ensure that there is free space on the EVA device.

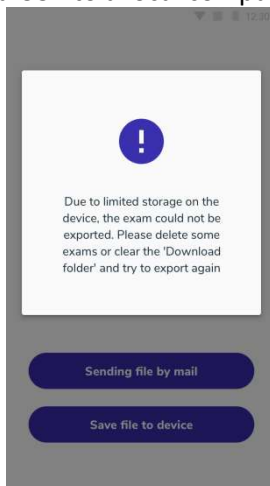

11.19. Reviewing exams on the app

- 11.19.1. To view examinations from the past 24 hours or to see the process of uploading examinations to the EVA Portal, tap on the menu button the top left in the home screen and tap on 'Exams'.

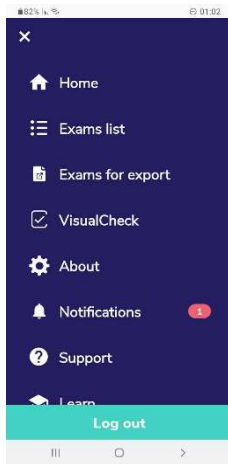

- 11.19.2. The Exams list shows exams created in chronological order with the most recent at the top. An icon next to each exam indicates the sync status (upload to the EVA online portal)
- 11.19.3. One of four options might be shown; draft (if the exam has not yet been completed,) In progress (if the exam is in the process of being synced,) Uploaded (if sync is completed,) or Opt-out (if exam was taken while being opt-out).
- 11.19.4. A USB symbol next to exam (in any state) indicates that an exam has been exported to the ZIP folder and ready to be exported manually via USB connection.

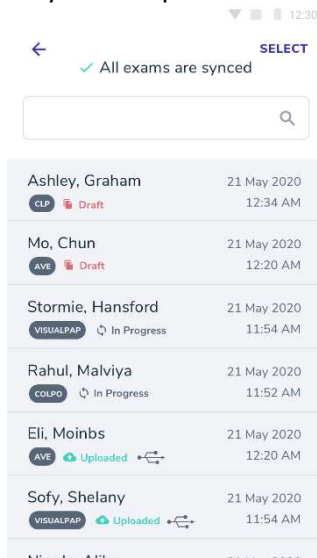

- 11.19.5. To view any exam on the device, click on any of them and the system will redirect to edit the exam.
- 11.19.6. Search bar is available on top of the exam list. Exams can be searched by patient's Name, Last name or MRN
- 11.19.7. No sync icon will be shown next to exams taken while in Opt-out mode. An icon at the top of the screen will indicate that the device is currently in opt-out mode. An icon will still indicate those exams that are ready for manual export via USB.

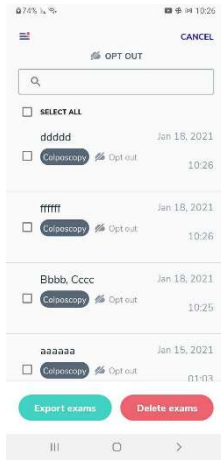

- 11.19.8.** Exams can be selected for export to ZIP (for manual export via USB) or deletion by clicking on the 'Select' button at the top right of the screen. Individual exams can then be selected for export or deletion from the device.
- Any exams that have previously been synced to the EVA Portal will still be saved on the Portal even if they are deleted from that particular device. Any exams captured in Opt-out mode or that have not been synced, will be permanently deleted from the system and cannot be retrieved. It is advisable to ensure that exams have been backed up either by manually or by syncing to the EVA Portal before deleting from the EVA Device.
 - Only exams that have been completed can be selected for export to ZIP. Exported exams can be reached via the main menu under "Exams for export." (see section 14)
- 11.19.9.** In the 'Uploaded' tab the examinations that finished uploading are displayed for 24 hours. Afterward, the exams can be viewed on the EVA portal: <https://eva.mobileodt.com>.
- 11.19.10.** If the device is not connected to Wi-Fi, an option to connect to Wi-Fi is presented. The upload process only works if the device is connected to the internet.

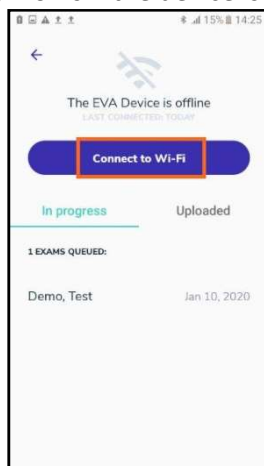

- 11.19.11.** If the device is not connected to Wi-Fi the exams in the device will be available in 'view mode' only.

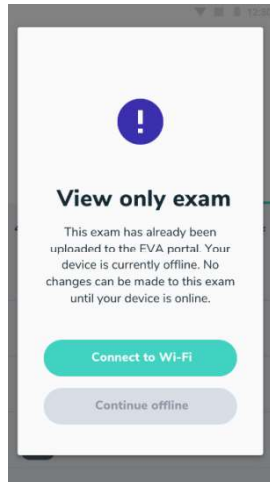

11.19.12. If there is a server error the exams will also be available in 'view-mode' only.

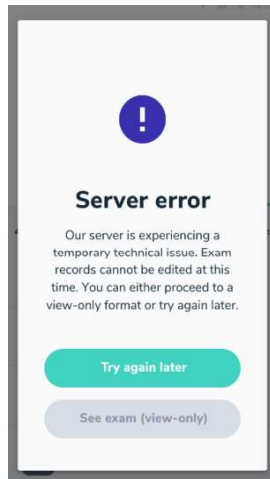

11.20. Deleting an exam

11.20.1. Users are able to delete exams and remove them permanently from that particular EVA Device.

11.20.2. Exams can only be deleted if they have either been

- synced to the online EVA Portal (where they are stored permanently unless deleted from the Portal,)
- exported as a ZIP file to the device Export internal storage for manual export via USB
- were a draft exam that was never completed.

11.20.3. If any exams that do not fit these criteria were selected for deletion, then a popup message will alert users to remove those exams from the deletion list.

11.20.4. A confirmation popup is displayed once an exam is selected for deletion. Exams cannot be retrieved once deleted.

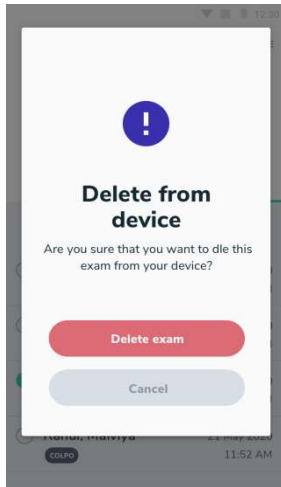

11.21. Exam Drafts

11.21.1. An option to save 'exam drafts' is available after entering all the patient details. The exams are saved as draft and are not synced until the exam is finished.



11.21.2. To access all the drafts, see the Exams list via the main menu.

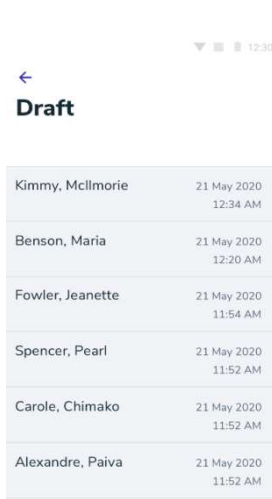

11.22. About

11.22.1. To access "About" section tap on the menu icon the top left icon the home screen.

- 11.22.2. Tap on 'About.'
- 11.22.3. In "About" section users can review the version of the app, the release date and device ID and read MobileODT's Terms of Use and Privacy Policy.

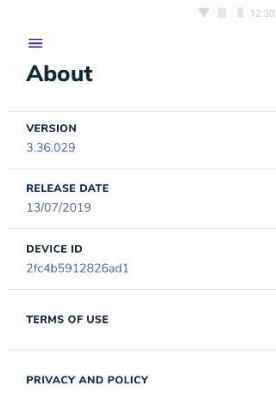

11.23. Handwave feature

The handwave feature allows users to capture images without touching the device. When the handwave feature is turned on, when performing an exam to capture an image, move the hand in a hi-five motion towards the MobileODT logo at the top of the device above the screen. This feature is configurable from the camera setting menu.

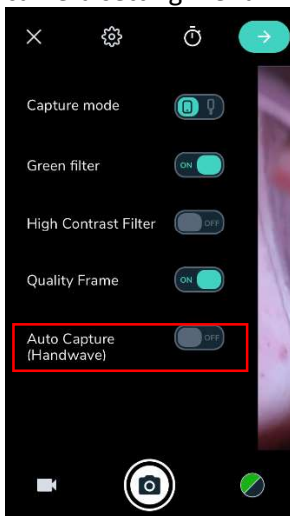

11.24. Camera mode

- 11.24.1. In 'Colposcope mode' the camera allows capturing images utilizing the magnification provided by the EVA System lens (up to 16x magnification.)
- 11.24.2. In 'Camera mode' Users can capture full-body or wide angle images. This disables the standard colposcope magnification provided by the EVA System lens, allowing the EVA Device to be used as a standard camera.
- 11.24.3. To attend maximum image quality camera mode, remove the mobile device from the casing, using the quick-release button at the top of the EVA device.

11.25. Quality frame

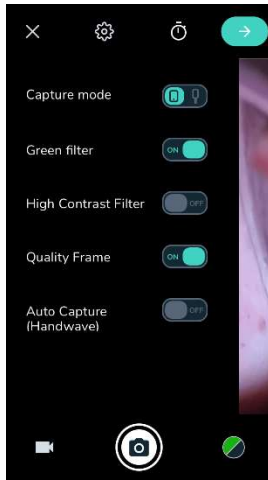
11.26. Support

- 11.26.1. To reach out to MobileODT support, tap on the menu icon at the top left of the screen.
- 11.26.2. In the menu section tap on 'Support.'
- 11.26.3. The support screen allows the user to connect with the MobileODT support team for further assistance.

11.27. Learn

- 11.27.1. To access the further training resources tap on the menu icon the top left of the screen.
- 11.27.2. In the menu section tap on 'Learn'. The learn button opens up MobileODT's knowledge center which contains more articles and videos.

11.28. Log out

- 11.28.1. To log out tap on the menu icon the top left of the home screen.
- 11.28.2. Tap on the 'Log out' button.

Appendices

12. Appendix 1: EVA COLPO

About EVA COLPO

The EVA COLPO model is designed to be used in the visual inspection of the cervix as part of routine cervical cancer screening, by a trained colposcopist. The software is designed to follow ASCCP guidelines for documenting a colposcopy procedure.

12.1. Add history of present illness

12.1.1. In the EVA COLPO clinical application, users can enter details of patient present and past illness once the basic patient identifying information has been entered by tapping on 'Add history of present illness.'

12.1.2. You can enter the following information:

- HPV status,
- Date of last Pap/HPV test,
- Pap result,
- Previous cervical biopsy taken,
- Previous cervical biopsy details,
- Previous cervical ablative or surgical procedure,
- Previous cervical ablative or surgical procedure details.

None of the fields are mandatory.

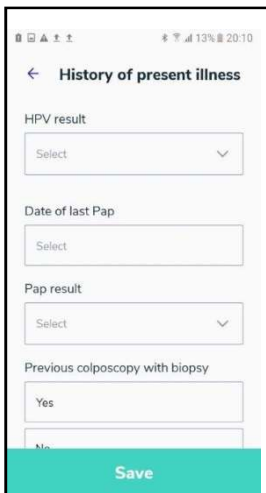

12.2. Colposcopic impression

12.2.1. Once you have completed the image capture, you will be prompted to document your colposcopic impression.

12.2.2. To finalize the documentation, tap on 'Add colposcopic impression,' and enter your clinical impression.

12.2.3. The following fields can be entered:

- Cervix visibility,
- SCJ visibility,
- ECC performed?,
- Vascular changes,
- Acetowhite changes,
- Lugol's changes,
- Satisfactory colposcopy,

- Colposcopic impression,
- Notes (this field allows you to record free notes.)

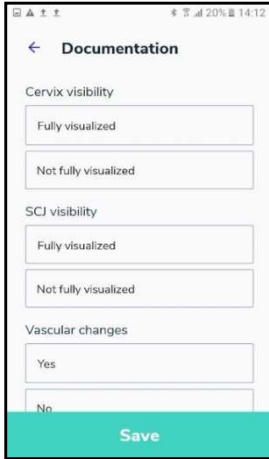

12.3. Optional features

12.3.1. For users in some markets, depending on regulatory approval the following extra features may be available:

- VisualCheck
- Quality Frame
- Zoom Telehealth

13. Appendix 2: EVA SANE

About EVA SANE

The EVA SANE model is designed to be used in the recording of visual evidence in the course of a sexual assault forensic exam by a trained practitioner.

13.1. Add additional details

13.1.1. When documenting patient injury with the EVA SANE model, users are prompted to add additional case details prior to capturing images.

13.1.2. Optional fields include:

- SANE examiner
- Time of patient arrival
- Day of Patient arrival
- Time of call to SANE
- Day of call to SANE
- Time of SANE arrival
- Day of SANE arrival
- Date of assault
- Time of assault
- Location of assault
- Patient was admitted (y/N)
- Admission notes
- Advocate called (Y/N)
- Advocate name

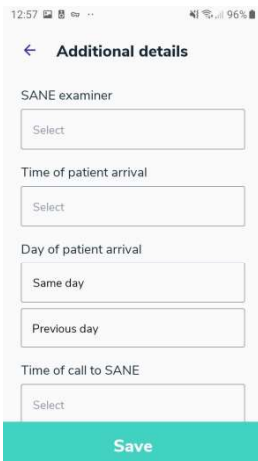

12:57 96%

← **Additional details**

SANE examiner
Select

Time of patient arrival
Select

Day of patient arrival
Same day
Previous day

Time of call to SANE
Select

Save

13.2. Add clinical impression

13.2.1. After images have been captured, the users have the option to add additional case notes under the 'Add Clinical impression' tab

13.2.2. The following fields are available:

- Complete DFSA
- Complete forensic kit

- Kit location
- Kit badge number
- STI prophylaxis
- HIV PEP
- Pregnancy prophylaxis
- Chief complaint
- Interpretation of anal-genital findings
- Needs further consultation/investigation (Y/N)
- Equipment decontaminated
- Notes
- Initials for signature

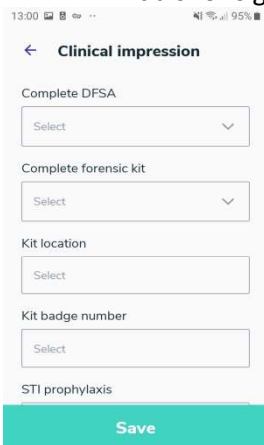

13.3. Additional features

13.3.1. Camera mode

EVA SANE users are able to utilize the ‘Camera mode’ feature which allows for the optical device to be removed from the casing and full body images to be captured and recorded.

For details see section 11.22

13.3.2. High contrast filter

A high contrast filter that highlights areas of vascularity and bruising is available for EVA SANE users.

It can be found on the capture screen next to the green filter button.

13.3.3. Optional features

Depending on market and regulatory status, the following optional features are available for EVA SANE users:

13.3.3.1. Zoom Telehealth

13.3.3.2. Bluetooth Foot Pedal

SANE users can use a Bluetooth foot pedal device in order to capture images and videos during an examination.

13.3.3.2.1. In order to connect, open the settings of the EVA device and turn Bluetooth on. Make sure the foot pedal Bluetooth device is turned on and pair the device to the EVA.

13.3.3.2.2. Start an exam in the EVA. Upon arriving at the Camera

screen you'll be able to use the Foot Pedal.

13.3.3.2.3.

First tap on the left/right foot pedal will connect the foot pedal to the EVA app. Whenever the Bluetooth is connected, a Bluetooth icon will be shown on the camera screen.



13.3.3.2.4.

In order to capture an image or start/stop a video, tap the left pedal.

13.3.3.2.5.

In order to take zoom in, tap on the right pedal.

13.3.3.2.6.

In order to zoom out, tap on the right pedal until you get to the max zoom in. Then, tap again and perform zoom out. Every tap is another zoom step.

14. Appendix 3: EVA VIA

About EVA VIA

The EVA VIA model is designed for users performing Visual Inspection with Acetic Acid (VIA) as form of primary cervical cancer screening. The designated clinical application software includes suitable documentation fields for the performance of VIA along WHO guidelines.

14.1. Add additional details

14.1.1. Prior to starting image capture, users are prompted to enter additional details about the patient and their history of illness.

14.1.2. Optional fields include:

- Number of children
- Number of vaginal deliveries
- Town/Village
- Date of last Pap
- Last Pap result
- HPV result
- Marital status
- Currently pregnant
- Screened in the past 5 years (Y/N)
- History of hysterectomy
- Chief complaint
- Screener Name
- Date of last menstrual period
- Previous evaluations and results
- Previous cervical ablative or surgical procedure notes
- Notes



← **Additional details**

Number of children
Select

Number of vaginal deliveries
Select

Town / village
Select

Date of last Pap
Select

Last Pap result

Save

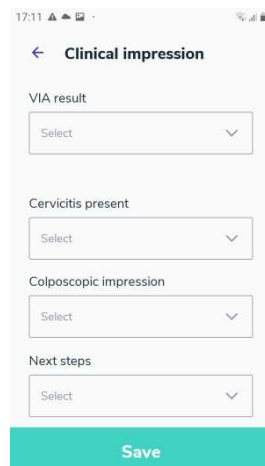

← **Clinical impression**

VIA result
Select

Cervicitis present
Select

Colposcopic impression
Select

Next steps
Select

Save

14.2. Add clinical impression

14.2.1. After image capture is complete, users have the option to add their clinical impression

14.2.2. Optional fields include:

- VIA result
- Cervicitis present
- Colposcopic impression
- Next steps
- Antibiotics prescribed
- Notes

14.3. Optional features

14.3.1. Additional features that are available in some markets depending on regulatory approval include:

- VisualCheck
- Quality Frame
- Zoom Telehealth

15. Appendix 4: VisualCheck**15.1. Intended use**

- VisualCheck is an automated visual evaluation of images of the cervix that provides information that may be useful in the characterization of suspected positive findings of colposcopy during image interpretation. VisualCheck is a digital computer aided triage and notification software indicated for use in the analysis of non-enhanced digital images as captured on a digital colposcope. VisualCheck is used by trained clinicians together with additional information to decide on prioritization of cases or the continued care of patients.
- VisualCheck is intended to assist hospital networks and clinicians trained in colposcopy and visual inspection of the cervix in workflow triage by flagging and communication of suspected positive findings of colposcopy and must always accompany a thoroughly performed visualization of the cervix.

VisualCheck for clinical decision support should be used only after a trained clinician performs a visual examination of the cervix and provides information that can be used by the clinician. VisualCheck is NOT a substitute for a visual examination through a digital colposcope and the clinician must ALWAYS conduct a thorough visual examination prior to using the VisualCheck.

- VisualCheck is to be used by a clinician trained in colposcopy and/or visual inspection of the cervix who performs a visualization of the cervix during a cervical cancer screening procedure.

15.2. Target population

15.2.1. The target population of this application is women between the ages of 30 to 49.

15.3. Warnings and Precautions

15.3.1. VisualCheck is currently not available in the USA. Please see your distributor to know your local availability in other regions

15.3.2. The VisualCheck assessment is not compatible with the following:

- Images in which acetic acid has not been adequately applied to the cervix
- Mucus on the cervix obscuring visualization of any of the squamo-columnar junction (SCJ)
- Any bleeding, discharge, or other feature that obscures the surface of the cervix, particularly around the squamo-columnar junction.
- Presence of vaginal wall retraction, or any other anatomical abnormality that prevents full visibility of the squamo-columnar junction and transformation zone (TZ).
- Parts of the speculum or swab obstruct full visibility of the squamo-columnar junction and transformation zone
- Images in which the squamo-columnar junction is not fully visible, including type III cervix

15.3.3. VisualCheck should not be used on pregnant or menopausal women or women whose squamo-columnar junction is not fully visible (cervix type 3)

15.3.4. VisualCheck is not regulated as a diagnostic tool and should not be used alone as replacement for a full and thorough visualization or colposcopic examination

15.3.5. Please note: at this time VisualCheck is only available for EVA System users.

15.4. Performing VisualCheck assessment

- 15.4.1. The VisualCheck assessment of cervical images can be performed from either the patient record view in the EVA Portal or from the EVA device software application.
- 15.4.2. Only images that meet the quality criteria for assessment will be included
- 15.4.3. Images acceptable for VisualCheck are images in which:
 - The cervix is in focus
 - All four quadrants of the cervix are visible
 - All of the cervix is well illuminated
 - No other artifacts are obstructing the view of the cervix
 - The cervix is clean from blood, mucus or other obstructions
- 15.4.4. Images must be collected during a cervical evaluation that includes:
 - cleaning of the cervix from blood and mucus
 - application of acetic acid

15.5. Running the VisualCheck analysis from the EVA device

In order to run VisualCheck analysis on the EVA device, the following steps should be done:

- 15.5.1. Conduct a cervical examination as per your standard guidelines
- 15.5.2. Finish the exam and you will be presented with the option to run VisualCheck

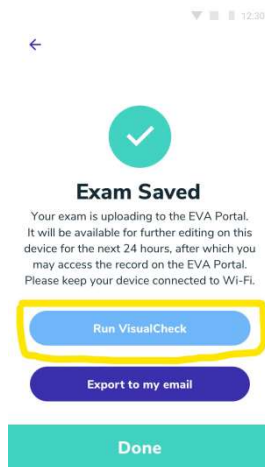

- 15.5.3. Click Run VisualCheck and you will be directed to the VisualCheck progress screen.
- 15.5.4. An indication of the progress of the process will be shown. You will be able to cancel the run while the exam's data sync to the cloud is in process.

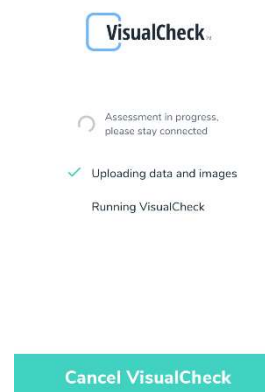

- 15.5.5. VisualCheck can also be run on past exams through the Exam list menu. To run VisualCheck on a past exam click on Main menu and then 'Exam list' to see a list of your recent exams.
- 15.5.6. When the exam is ready to run VisualCheck, 'VisualCheck ready' will show next to the exam entry

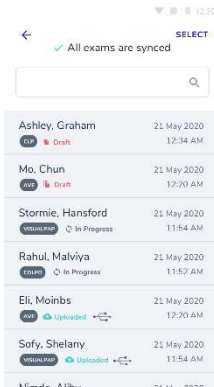

- 15.5.7. Click on the exam entry to open the exam summary
- 15.5.8. Click on 'Run VisualCheck' to start the assessment.
- 15.5.9. Depending on internet connectivity, results should be returned in approximately 1 minute. One of four possible results will be returned normal, abnormal, incomplete or inconclusive. (see section 40.3 for details).
- 15.5.10. If images were added/deleted, or if the result on VisualCheck run was Incomplete/Inconclusive, you are advised to run VisualCheck again, in order to get an updated result.

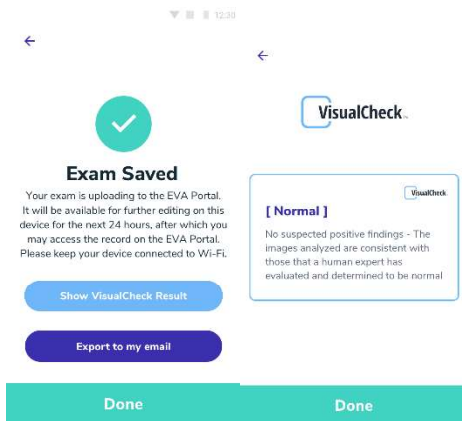

15.6. Running VisualCheck analysis from the EVA Portal

To run the VisualCheck analysis from the EVA Portal, there are 4 steps

- 15.6.1. Log into the EVA Portal, where you will see a list of your recent exams.
- 15.6.2. Find the exam on which you wish to run VisualCheck. Click on the entry to open the exam summary. Please note - VisualCheck can be run only on exams that you created.
- 15.6.3. Scroll down the exam summary to find the VisualCheck box
- 15.6.4. To start the VisualCheck assessment, click the button "Run assessment."

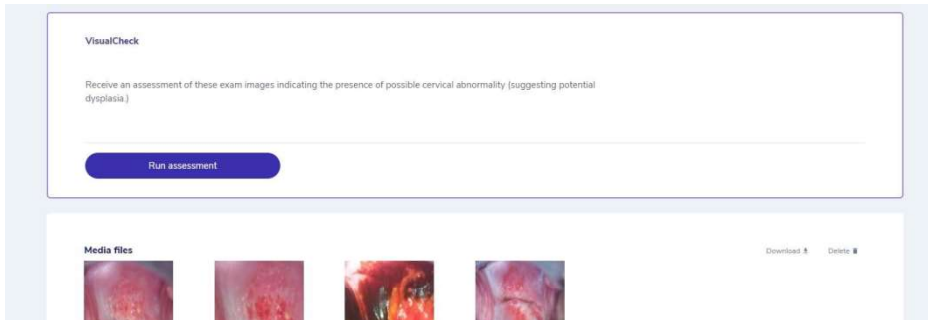

- 15.6.5. The images assessed by the VisualCheck cloud classifier to give an indication of how an expert colposcopist would likely assess similar images.
- 15.6.6. One of four possible results will be returned: normal, abnormal, incomplete or inconclusive. (see section 15.7 for details).
- 15.6.7. It is necessary to maintain WiFi connection throughout the VisualCheck process, on both the EVA Device or Portal, or an incomplete result will be returned.
- 15.6.8. VisualCheck will automatically assess the 8 most recent images included in that exam entry. If more images are added and the VisualCheck assessment is repeated, it will provide an analysis of the most recent images.
- 15.6.9. If images are added to or removed from the exam record, then the previous VisualCheck result will no longer be displayed. You will need to rerun the VisualCheck to receive a new assessment.
- 15.6.10. If an incomplete or inconclusive result is returned, then it is possible to repeat the exam once the issues impeding the process are resolved.

15.7. VisualCheck results

One of four possible results will be returned by the VisualCheck assessment:

15.7.1. Abnormal

An 'Abnormal' result indicates suspected positive findings. The images analyzed in this assessment are consistent with those evaluated and determined to be abnormal by expert colposcopists.

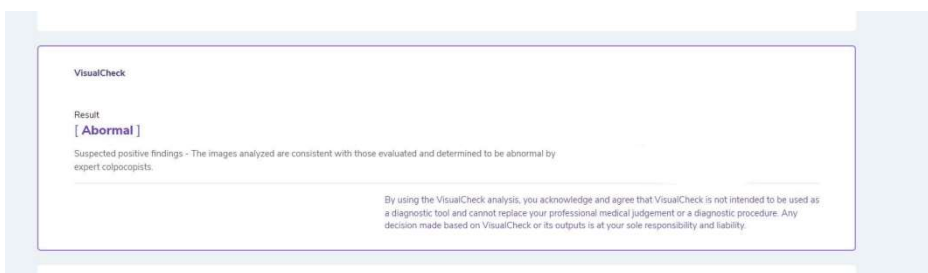

15.7.2. Normal

A 'Normal' result indicates that based on this assessment the images analyzed are consistent with those evaluated and determined to be normal (CIN 1 or lower) by expert colposcopists.

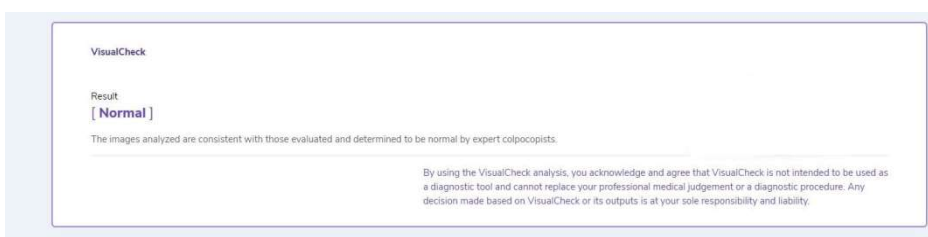

15.7.3. Inconclusive

An 'Inconclusive' result indicates that VisualCheck was unable to reach a conclusion based on the current image data.

- If VisualCheck results were inconclusive it means that the images captured during the exam were not suitable for the VisualCheck algorithm to analyze.
- A number of factors can lead to an inconclusive result (e.g the patient could have moved, there is too much mucus or blood, or the cervix itself was not suitable for the VisualCheck exam (e.g. a type 3 cervix.) It is recommended to repeat the test or perform an alternate form of screening.

15.7.4. Incomplete

The results 'incomplete' indicates that VisualCheck was not able to complete the assessment for technical reasons.

- The most likely cause of an incomplete result is the loss of WiFi connection, although other technical issues, such as server failure, could produce an incomplete result. It is recommended to repeat the test.

16. Appendix 5: Quality frame
About the Quality frame

The Quality frame is an AI-based tool that detects the presence of a cervix within the screen of the EVA device. It then assesses the image to see if the image quality meets the criteria to be designated a suitable image for visual inspection of the cervix.

16.1. Using the Quality frame

- 16.1.1. The quality frame feature guides users to capture high quality cervical images. When turned on this feature presents a grey or green frame on the screen of the EVA device during visualization/image capture.
- 16.1.2. A green frame indicates that quality (a combination of focus, image quality and positioning of the cervix in the image) is excellent. A grey frame indicates usable quality for cervical examination. In case no cervix is being identified by the camera, no frame will appear
- 16.1.3. Users can capture images or video at any point regardless of the quality fame indication.



17. Appendix 6: Teleconsultation (Zoom Telehealth)

About the Teleconsultation feature

The teleconsultation feature on the EVA System allows for remote proctorship and consultation among clinicians.

Using the third party Zoom application on the EVA device, a clinician in a remote location is able to supervise the clinician at the point of care in real-time.

17.1. Installing the Zoom Application

- 17.1.1. Before the Zoom application can be installed, MobileODT admin need to 'push' the app to your device.
- 17.1.2. To request this feature, please contact MobileODT support on support@mobileodt.com and provide them with your username and device ID number.
- 17.1.3. To install Zoom on the Smartphone:
- 17.1.4. If you have the MaaS360 MDM installed on the phone (you know you have it if you see the MobileODT logo on the EVA device screen):
- 17.1.5. Open EVA device and tap on the MaaS360 application, found on the home screen
- 17.1.6. Choose App Catalog.
- 17.1.7. Click Zoom and install
- 17.1.8. If you don't see the Zoom Application as an option, please email support@mobileodt.com with your username and device ID.

17.2. Initiating a teleconsultation connection

Once the Zoom application is installed, to share your EVA device screen:

- 17.2.1. Open the Zoom app and Sign Up or Sign In.
- 17.2.2. Click Start A Meeting.
- 17.2.3. Turn the video off
- 17.2.4. Enable 'Use Personal Meeting ID'
- 17.2.5. To share the phone screen click 'share' at the bottom and share screen
- 17.2.6. The participants at the remote location now need to browse to <http://zoom.us> and click 'JOIN A MEETING'. (they do not need to sign up with Zoom).
- 17.2.7. Tap your screen while in the Zoom application to get your personal meeting ID and give it to the remote consultant.
- 17.2.8. The remote participant enters the meeting ID that you provided into their screen under join a meeting.
- 17.2.9. Once they have joined the meeting they should now be able to see your screen and speak directly to you via the EVA device.